



DEBAKEY



**10-001-080**  
Length 8 cm  
Jaw 2 cm  
Straight



**10-002-090**  
Length 9 cm  
Jaw 3 cm  
Straight



**10-003-105**  
Length 10.5 cm  
Jaw 4.5 cm  
Straight



**10-004-125**  
Length 12.5 cm  
Jaw 6.8 cm  
Straight



DEBAKEY

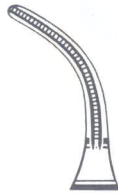

**10-005-075**  
Length 7.5 cm  
Jaw 2 cm  
Curved

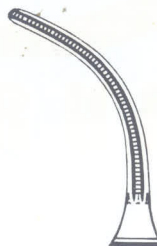

**10-006-085**  
Length 8.5 cm  
Jaw 3 cm  
Curved



**10-007-095**  
Length 9.5 cm  
Jaw 4.5 cm  
Curved



**10-008-115**  
Length 11.5 cm  
Jaw 6.8 cm  
Curved



**BULLDOG CLAMP**



**10-009-038**  
3.8 cm



**10-010-038**  
3.8 cm



**10-013-060**  
6 cm



**10-011-051**  
5.1 cm



**10-012-060**  
6 cm



**10-014-060**  
6 cm



**DIETRICH/MICRO CORONARY**



**10-015-050**  
5 cm  
Straight, 8 mm



**10-016-050**  
5 cm  
Angled, 8 mm

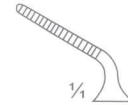

**10-017-050**  
5 cm  
Angled, 12 mm



**BULLDOG CLAMP**

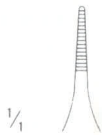

**10-018-049**  
Length 4.9 cm  
Jaw 8 cm  
Straight



**10-019-053**  
Length 5.3 cm  
Jaw 1.2 cm  
Straight

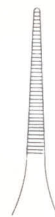

**10-020-059**  
Length 5.9 cm  
Jaw 2 cm  
Straight



**10-021-043**  
Length 4.3 cm  
Jaw 8 cm  
Curved



**10-022-045**  
Length 4.5 cm  
Jaw 1.2 cm  
Curved

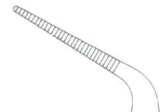

**10-023-050**  
Length 5 cm  
Jaw 2 cm  
Curved

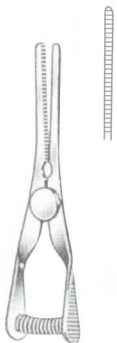

**10-024-040**  
Titan 4 cm

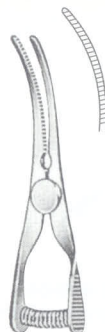

**10-025-040**  
Titan 4 cm



**10-026-040**  
Titan 4 cm



**10-027-040**  
Titan 4 cm  
Full Curved



**10-028-049**  
Length 4.9 cm  
Jaw 1.3 cm  
Straight



**10-029-054**  
Length 5.4 cm  
Jaw 1.8 cm  
Straight



**10-030-061**  
Length 6.1 cm  
Jaw 2.5 cm  
Straight



**WICKHAM MINI**

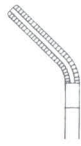

**10-031-047**  
Length 4.7 cm  
Jaw 1.3 cm  
Curved

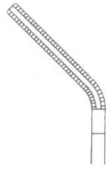

**10-032-051**  
Length 5.1 cm  
Jaw 1.8 cm  
Curved

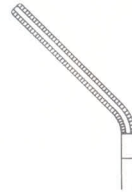

**10-033-055**  
Length 5.5 cm  
Jaw 2.5 cm  
Curved



**WICKHAM**  
**10-034-240**  
24 cm



**10-035-047**  
Length 4.7 cm  
Jaw 1 cm  
Straight



**10-036-051**  
Length 5.1 cm  
Jaw 1.4 cm  
Straight



**10-037-057**  
Length 5.7 cm  
Jaw 2 cm  
Straight



**DEBAKEY-DIETRICH**



**10-038-044**  
Length 4.4 cm  
Jaw 1 cm  
Curved



**10-039-046**  
Length 4.6 cm  
Jaw 1.4 cm  
Curved



**10-040-049**  
Length 4.9 cm  
Jaw 2 cm  
Curved



**10-041-054**  
Length 5.4 cm  
Jaw 2 cm  
Curved









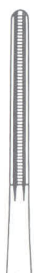

**JOHN-HOPKINS**  
**10-042-245**  
24.5 cm

# THORACIC/CARDIOVASCULAR



DE BAKEY



- |  |   |  |
|--|---|--|
| <br>1/4<br><b>10-043-150</b><br>15 cm | <br><b>10-044-195</b><br>19.5 cm | <br><b>10-045-240</b><br>24 cm  |
| <br><b>10-046-150</b><br>15 cm        | <br><b>10-047-195</b><br>19.5 cm | <br><b>10-049-150</b><br>15 cm  |
| <br><b>10-048-240</b><br>24 cm       | <br><b>10-050-195</b><br>19.5 cm | <br><b>10-051-240</b><br>24 cm |



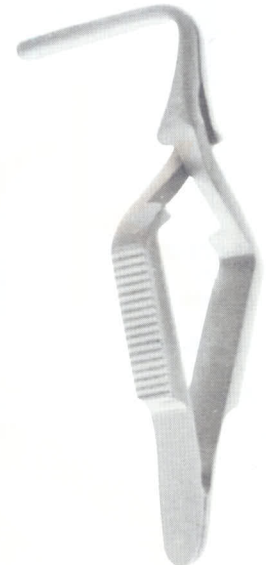

**10-052-110**  
11 cm

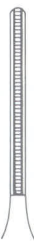

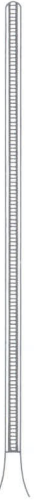
**10-053-001**

- |   |  |
|---|--|
| <br>1/4<br><b>10-054-075</b><br>7.5 cm | <br><b>10-055-085</b><br>8.5 cm |
| <br><b>10-055-105</b><br>10.5 cm      | <br><b>10-056-120</b><br>12 cm |

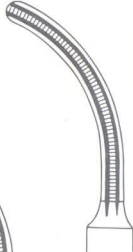
Bulldog

- |  |  |   |
|--|--|---|
| <br>1/4<br><b>10-057-075</b><br>7.5 cm | <br><b>10-058-085</b><br>8.5 cm | <br><b>10-059-105</b><br>10.5 cm |
| <br><b>10-060-120</b><br>12 cm        |  |   |



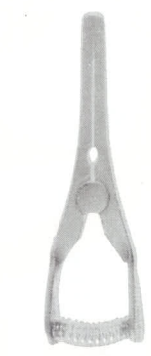





DE BAKEY



VEIN ARTERY



VEIN ARTERY

- |  |   |   |
|--|---|---|
| <br>1/4<br><b>10-061-030</b><br>3 cm | <br><b>10-062-030</b><br>3 cm   | <br><b>10-065-040</b><br>4 cm        |
| <br><b>10-063-035</b><br>3.5 cm      | <br><b>10-064-035</b><br>3.5 cm | <br><b>10-067-055</b><br>5.5 cm      |
| <br>1/4<br><b>10-069-030</b><br>3 cm | <br><b>10-070-030</b><br>3 cm   | <br>1/4<br><b>10-073-040</b><br>4 cm |
| <br><b>10-071-035</b><br>3.5 cm      | <br><b>10-072-035</b><br>3.5 cm | <br>1/4<br><b>10-074-040</b><br>4 cm |
|  |   | <br><b>10-075-055</b><br>5.5 cm      |

VEIN ARTERY



DE BAKEY



10-078-200  
20 cm  
Straight

10-079-200  
20 cm  
Angular

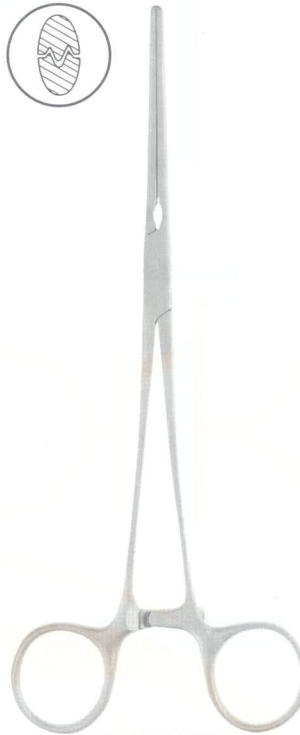

DE BAKEY

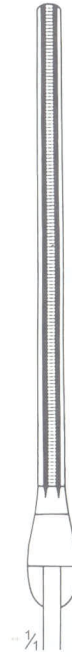

10-080-210  
21 cm  
Straight

10-081-210  
21 cm  
Angular



DE BAKEY

10-082-265  
26.5 cm



DE BAKEY

10-083-265  
26.5 cm



# THORACIC/CARDIOVASCULAR

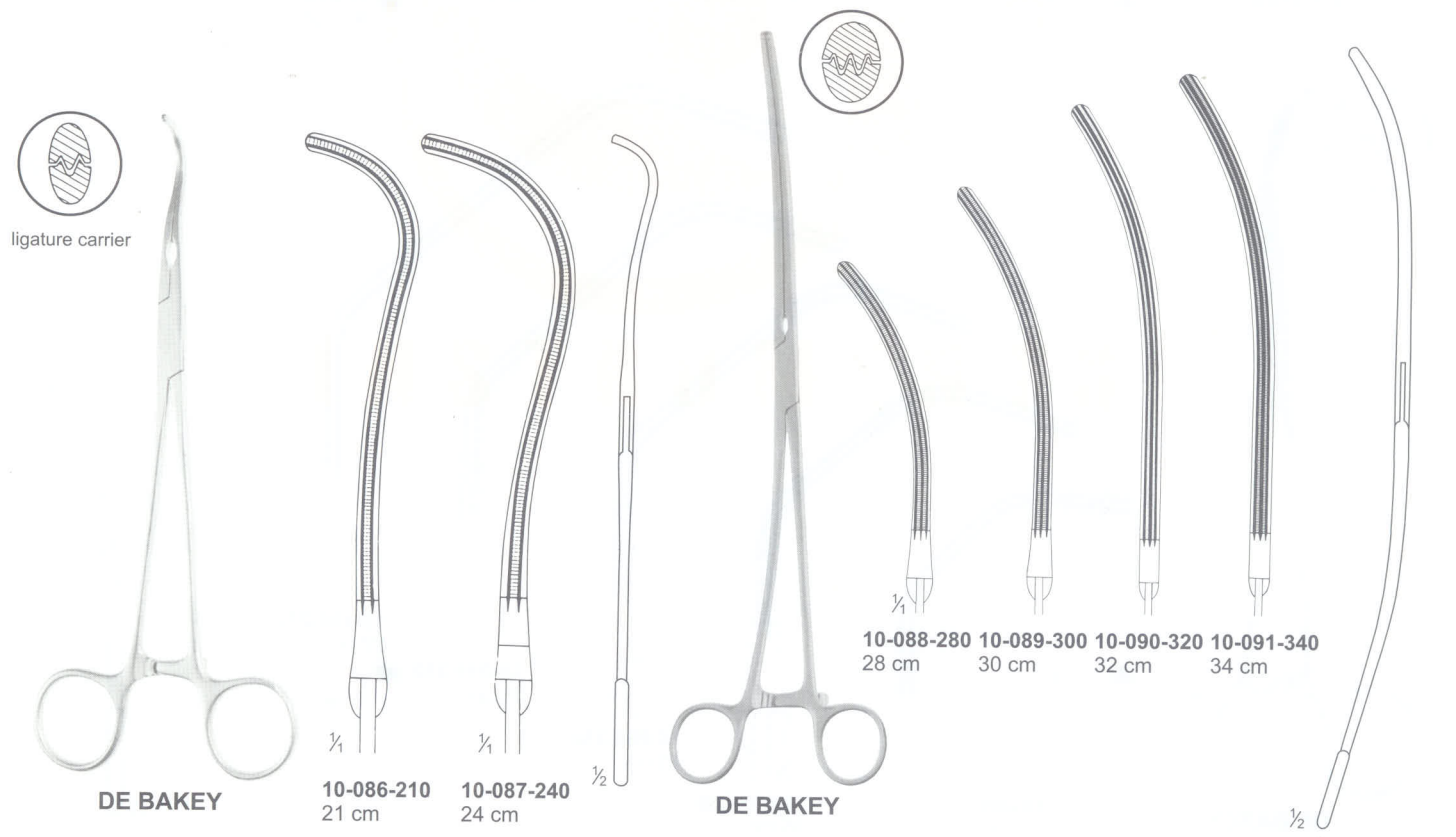
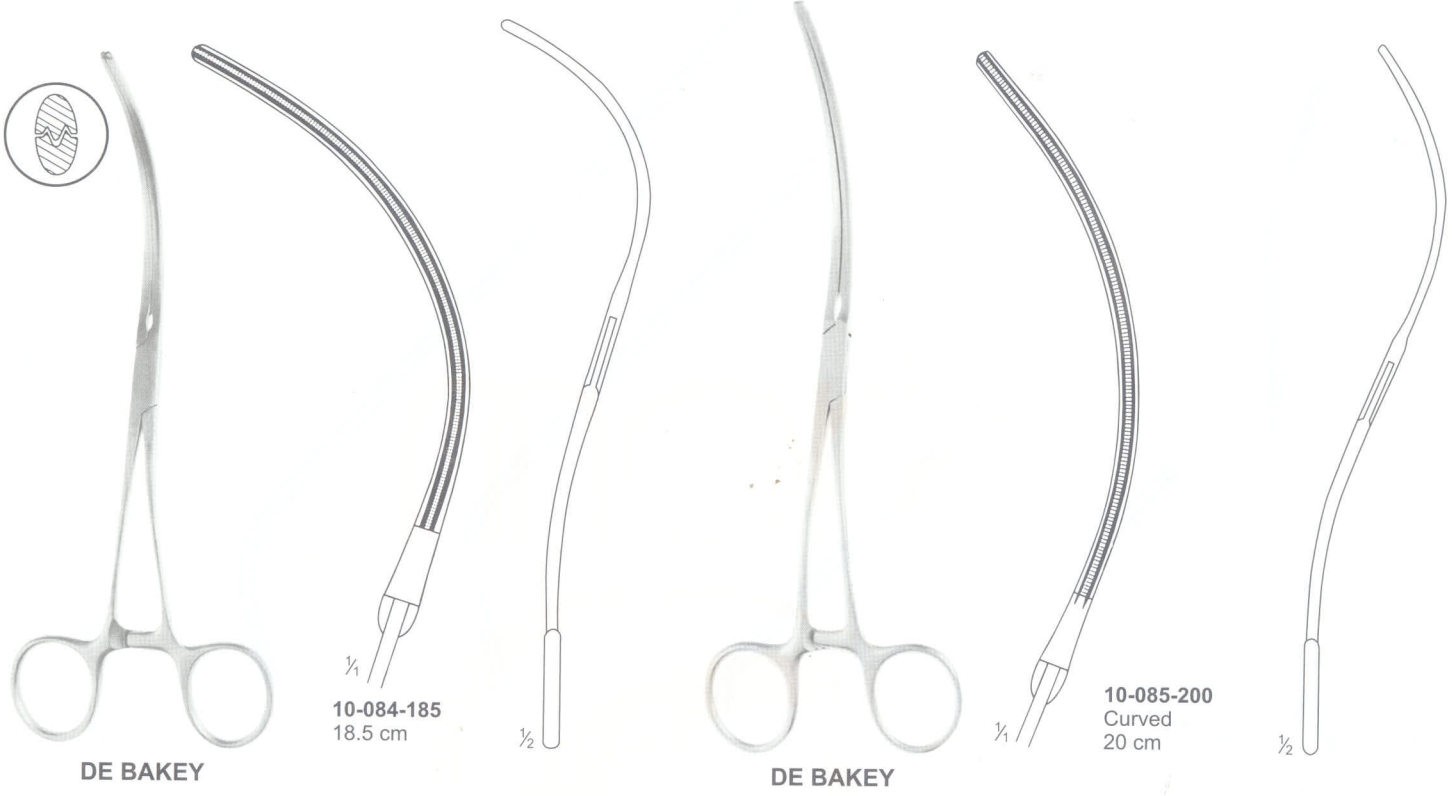



60° angled jaws

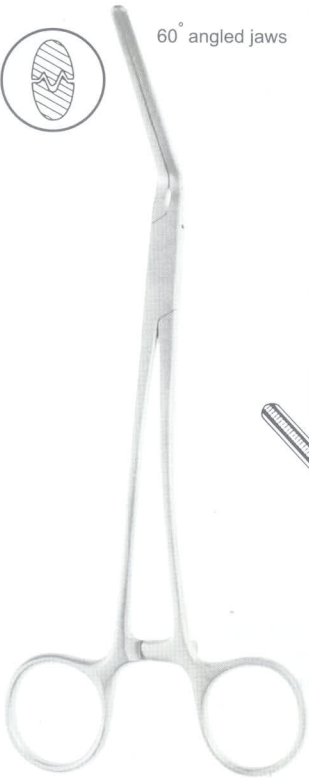

DE BAKEY

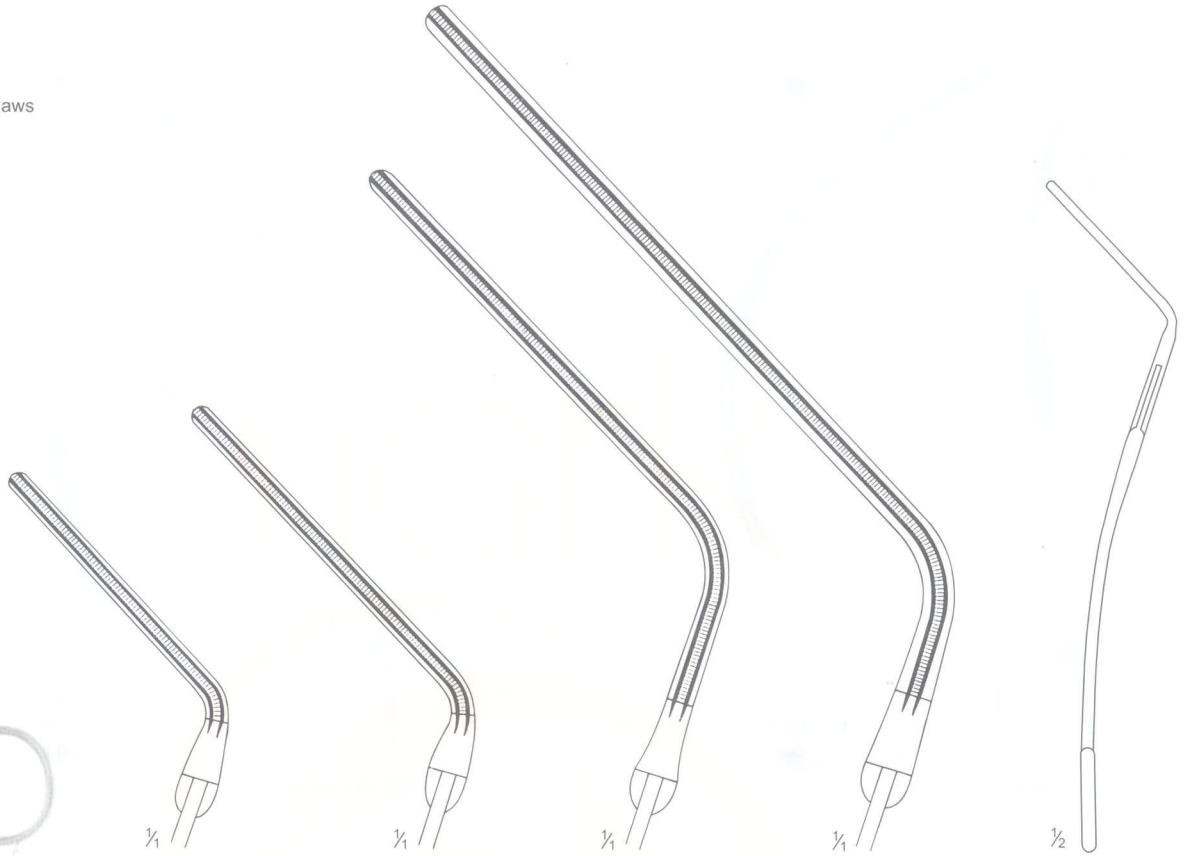

10-092-215  
21.5 cm

10-093-235  
23.5 cm

10-094-250  
25 cm

10-095-305  
30.5 cm

1/2



DE BAKEY

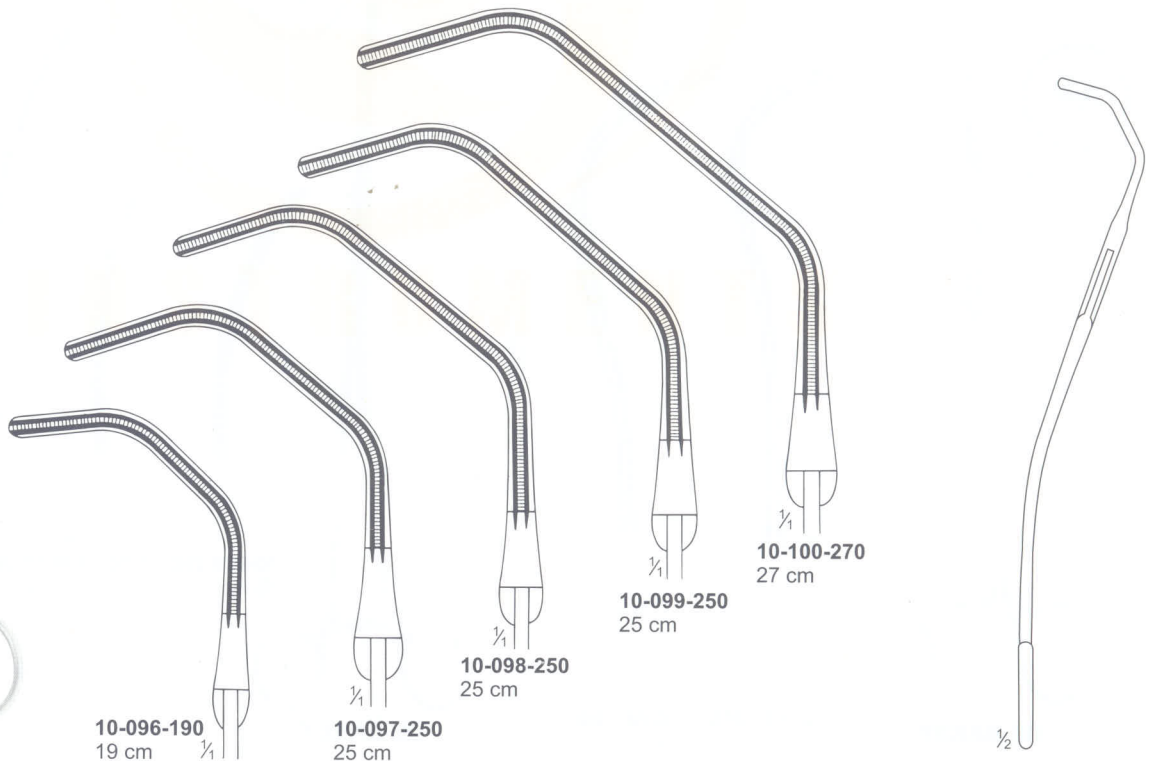

10-096-190  
19 cm

10-097-250  
25 cm

10-098-250  
25 cm

10-099-250  
25 cm

10-100-270  
27 cm

1/2

# THORACIC/CARDIOVASCULAR

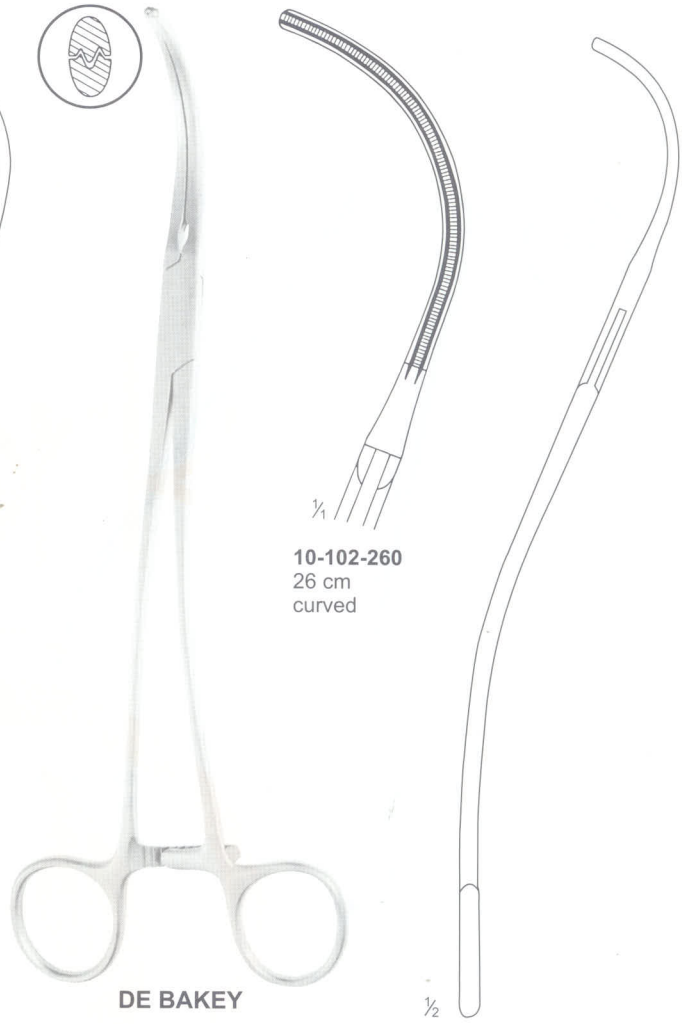
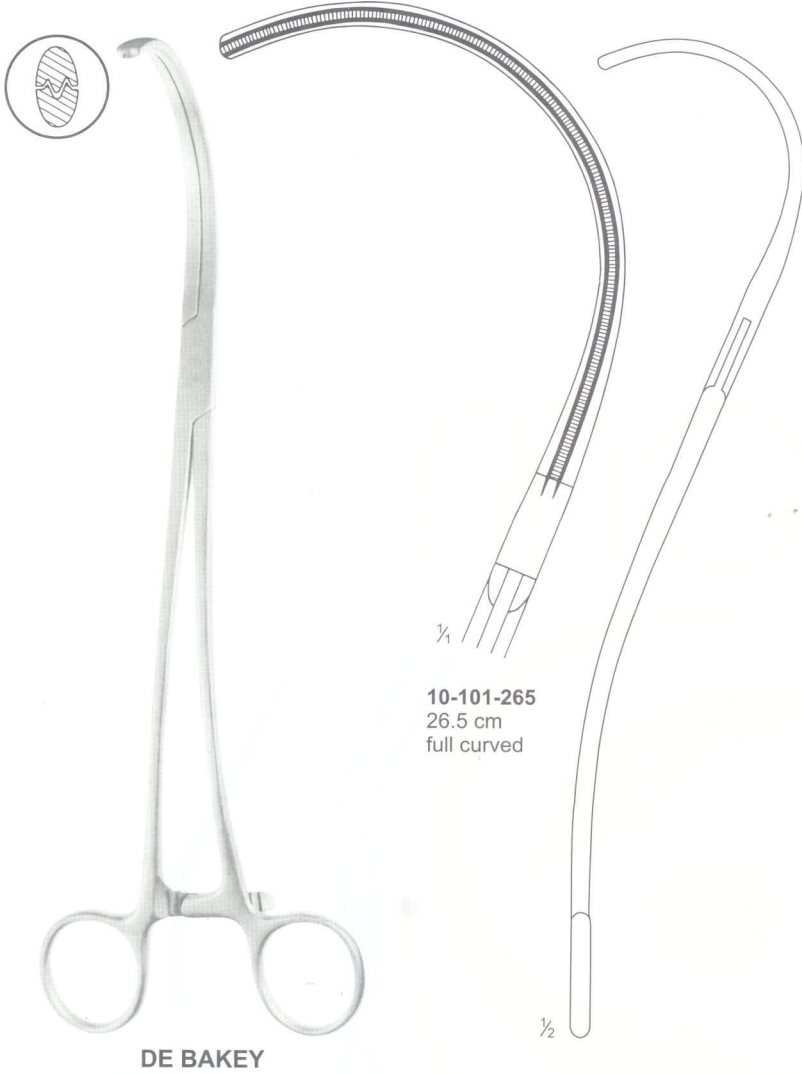





DE BAKEY



1/4  
10-104-180  
18 cm

1/4



DE BAKEY / PEDIATRIC

1/4

10-105-120  
12 cm  
Angled, 43mm tip

# THORACIC/CARDIOVASCULAR



10-106-210  
21 cm

10-107-240  
24 cm

GLOVER

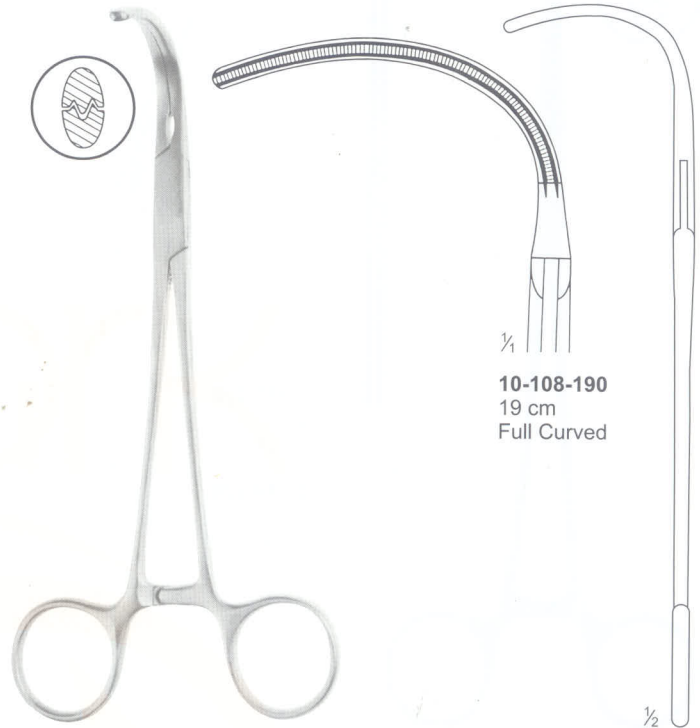

10-108-190  
19 cm  
Full Curved

GLOVER

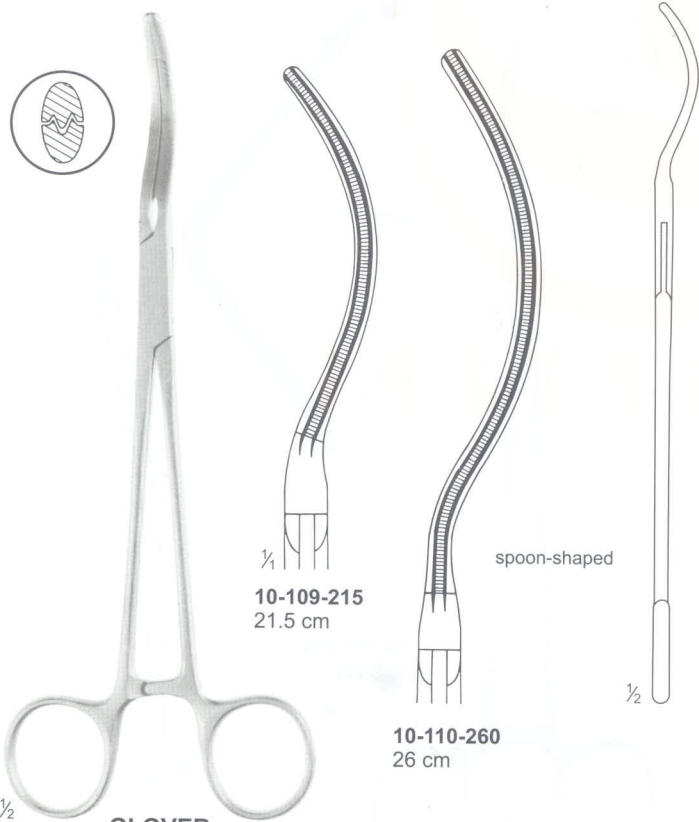

10-109-215  
21.5 cm

spoon-shaped

10-110-260  
26 cm

GLOVER



10-111-200  
20 cm  
Straight

10-112-200  
20 cm  
Angular

GLOVER



GLOVER



10-113-220  
22 cm  
Straight

10-114-220  
22 cm  
Angular



1/2

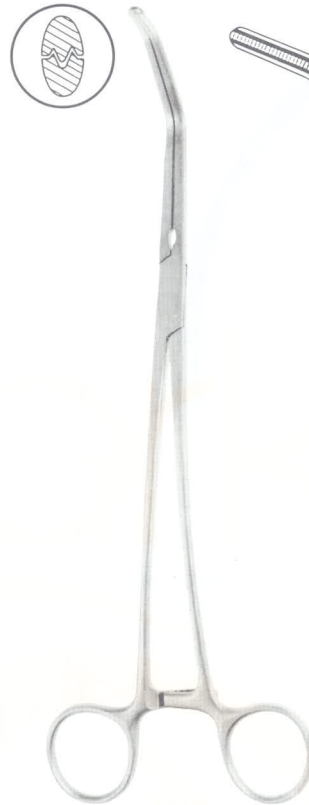

GLOVER



10-115-250  
25 cm



1/2



LEES

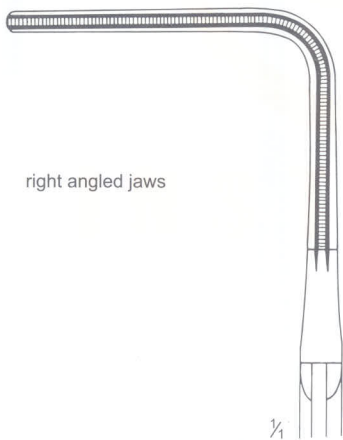

right angled jaws

10-116-220  
22 cm



1/2



LEES



double bent

10-117-235  
23.5 cm

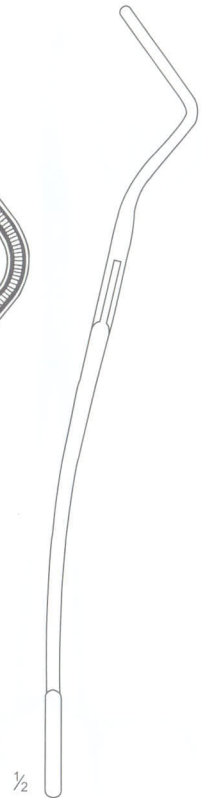
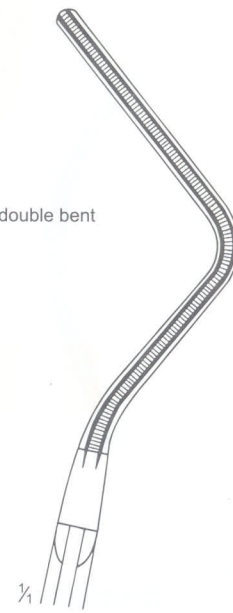

1/2

# THORACIC/CARDIOVASCULAR

10-118-170 17 cm  
10-119-180 18 cm  
60 angled small jaws

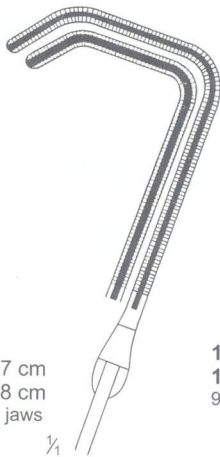

10-120-170 17 cm  
10-121-180 18 cm  
90 angled small jaws

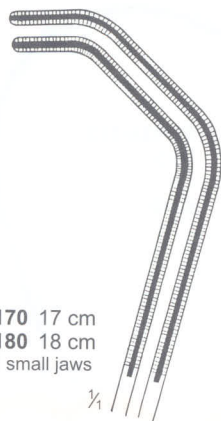

COOLEY

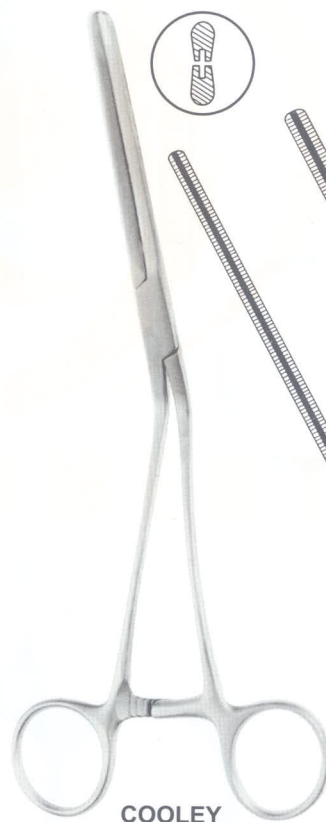

COOLEY

10-122-215  
21.5 cm

10-123-260  
26 cm

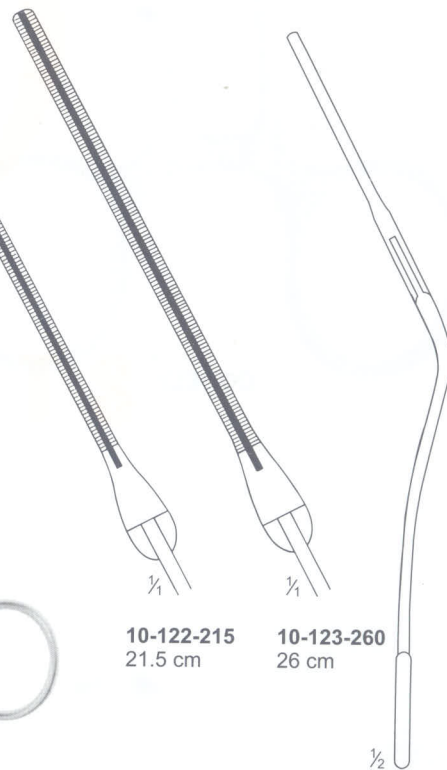

1/2

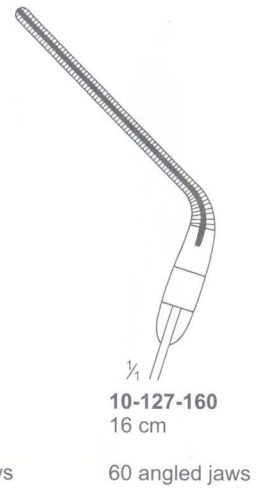
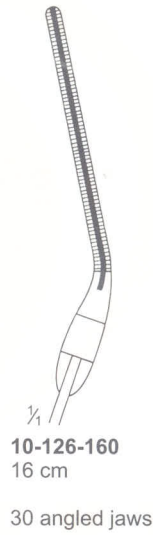
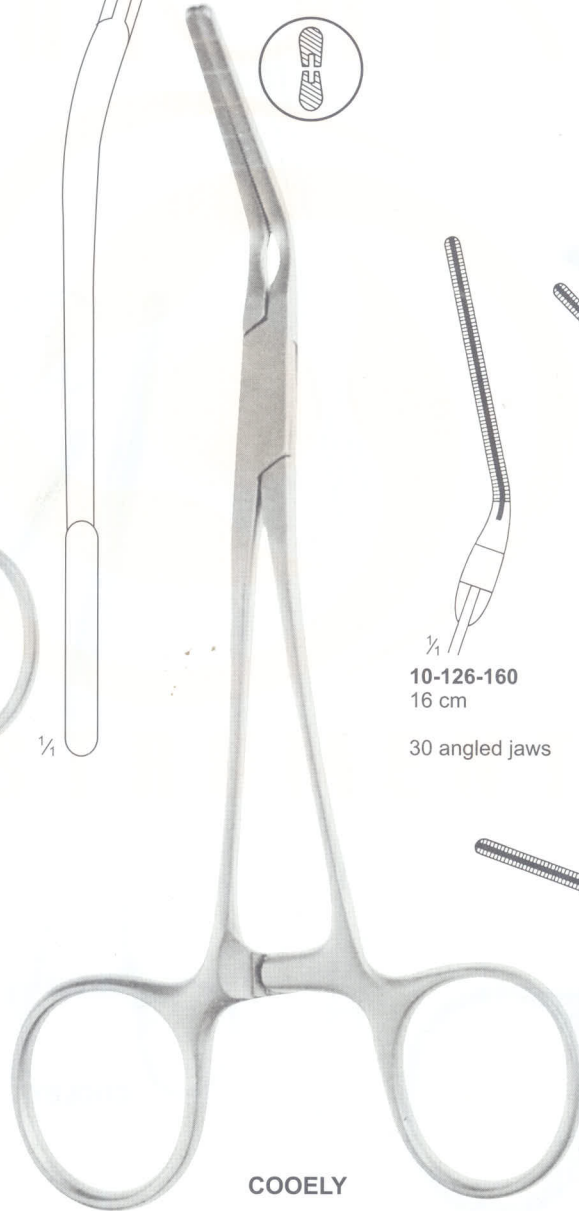
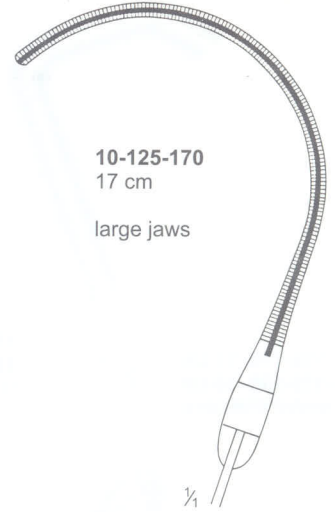
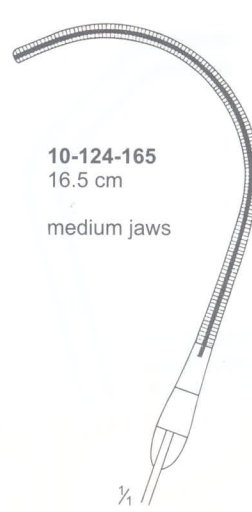

# THORACIC/CARDIOVASCULAR



straight jaws  
angled shanks



10-129-160  
16 cm  
straight shafts  
10-130-160  
16 cm  
angular shafts

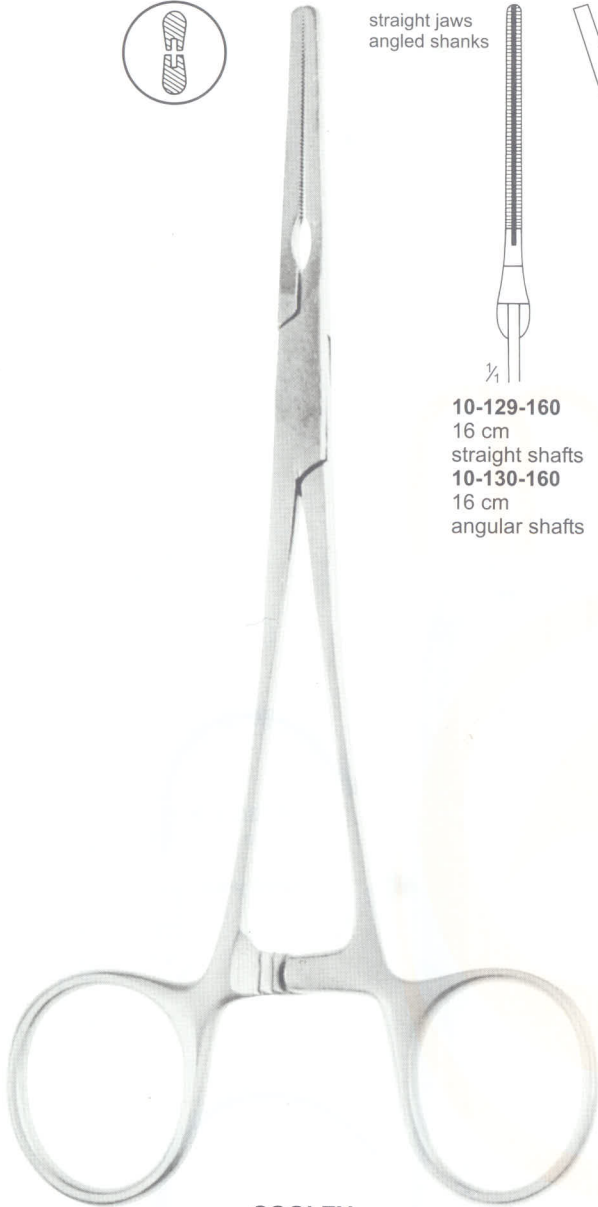

COOLEY



1/4

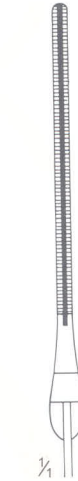

10-131-170  
17 cm  
straight jaws

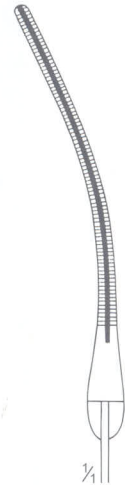

10-132-170  
17 cm  
curved jaws

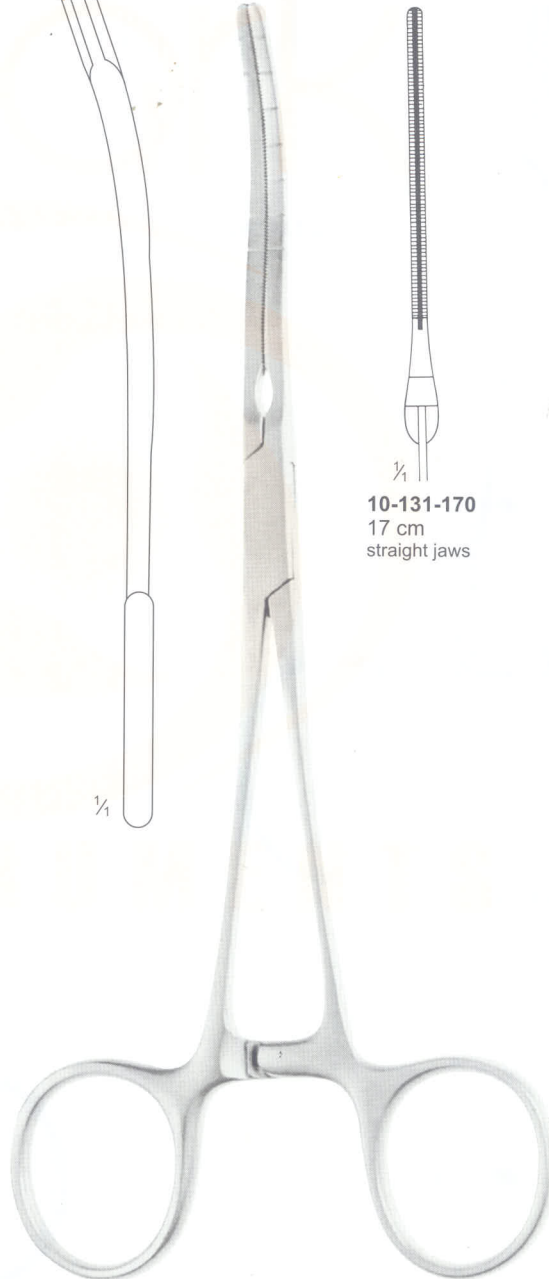

COOLEY  
clamping forceps for coarctation



10-133-170  
17 cm  
spoon-shaped  
jaws

1/4

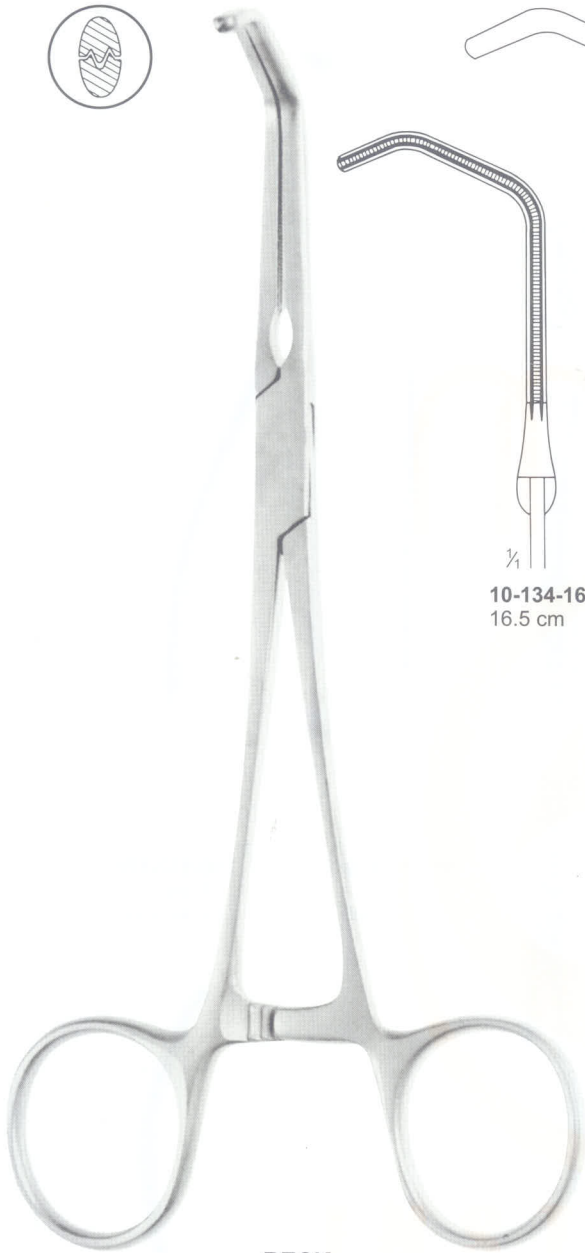

10-134-165  
16.5 cm

BECK

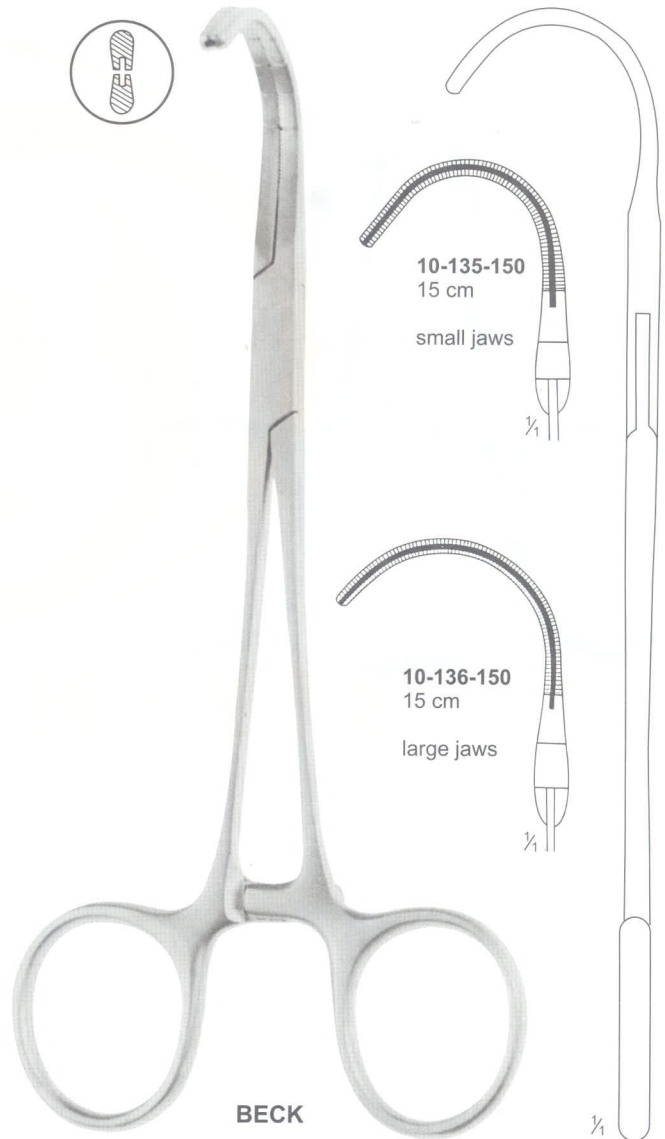

10-135-150  
15 cm  
small jaws

10-136-150  
15 cm  
large jaws

BECK



# THORACIC/CARDIOVASCULAR

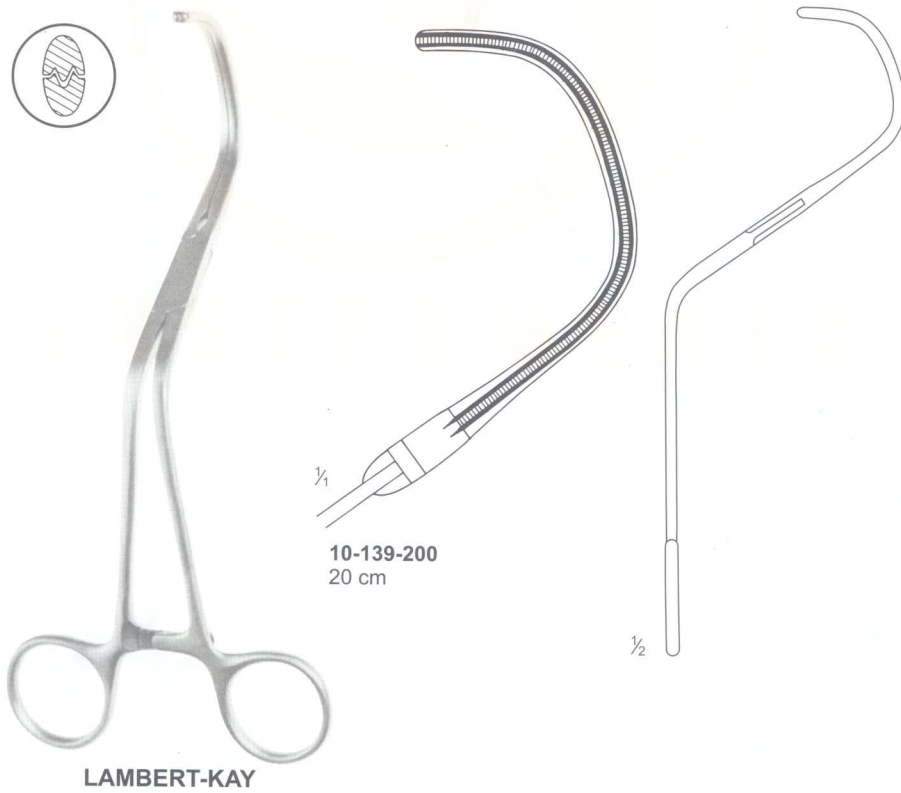
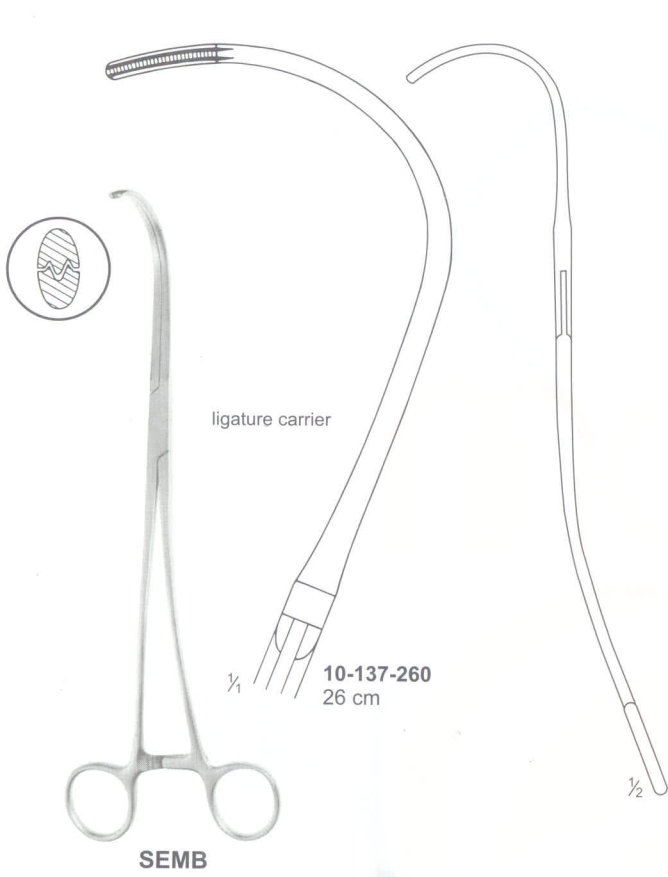



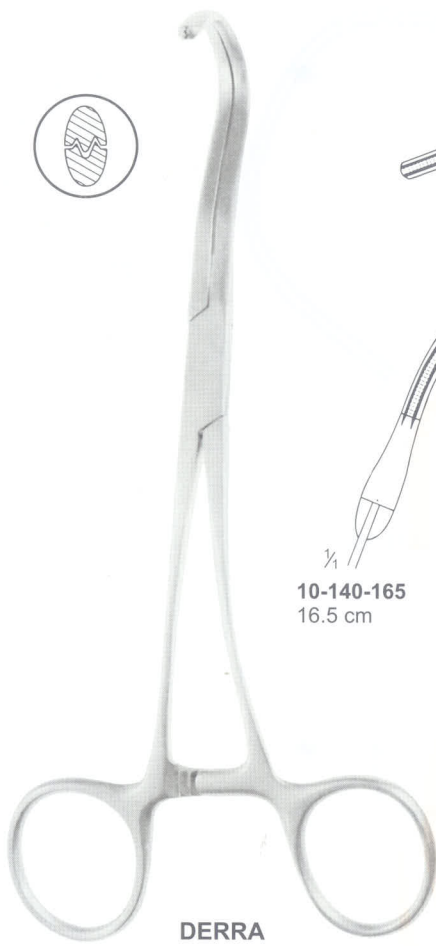

DERRA

10-140-165  
16.5 cm

10-141-170  
17 cm

10-142-180  
18 cm

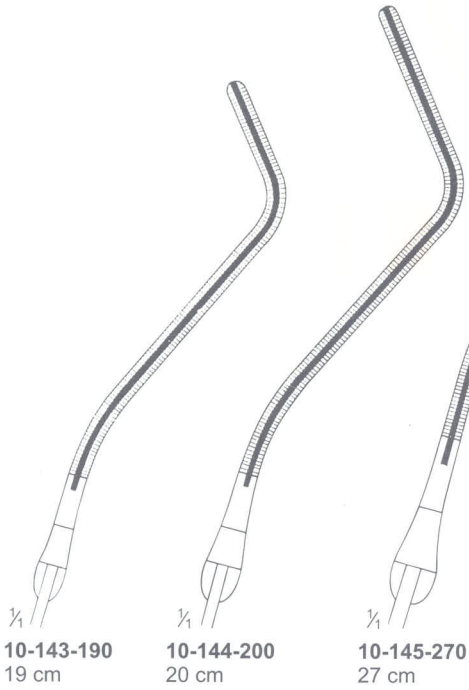

10-143-190  
19 cm

10-144-200  
20 cm

10-145-270  
27 cm

double bent jaws  
curved shanks



RENAL

THORACIC/CARDIOVASCULAR



**SATINSKY**  
10-146-205  
20.5 cm

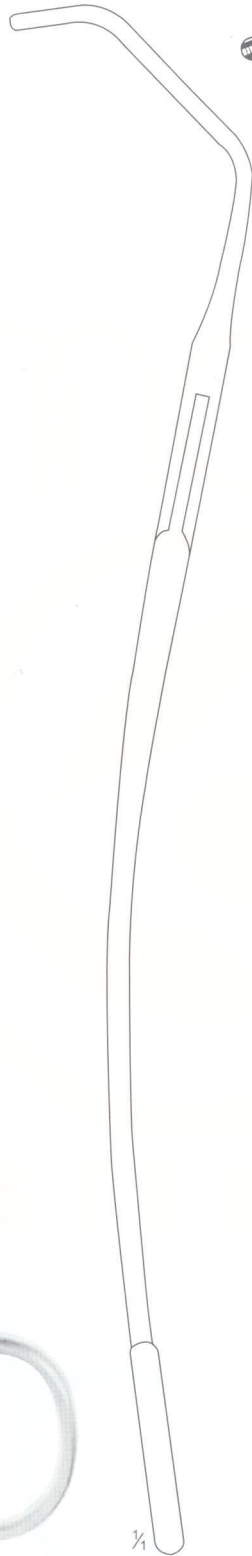

$\frac{1}{4}$

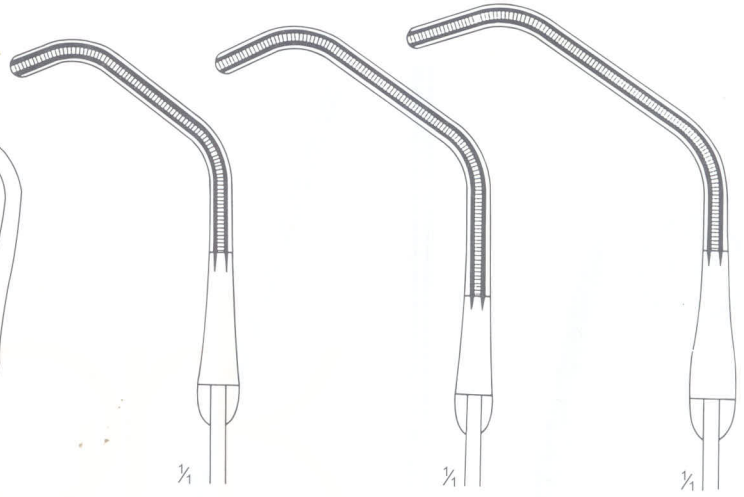

$\frac{1}{4}$   
**10-147-250**  
25 cm

$\frac{1}{4}$   
**10-148-250**  
25 cm

$\frac{1}{4}$   
**10-149-250**  
25 cm

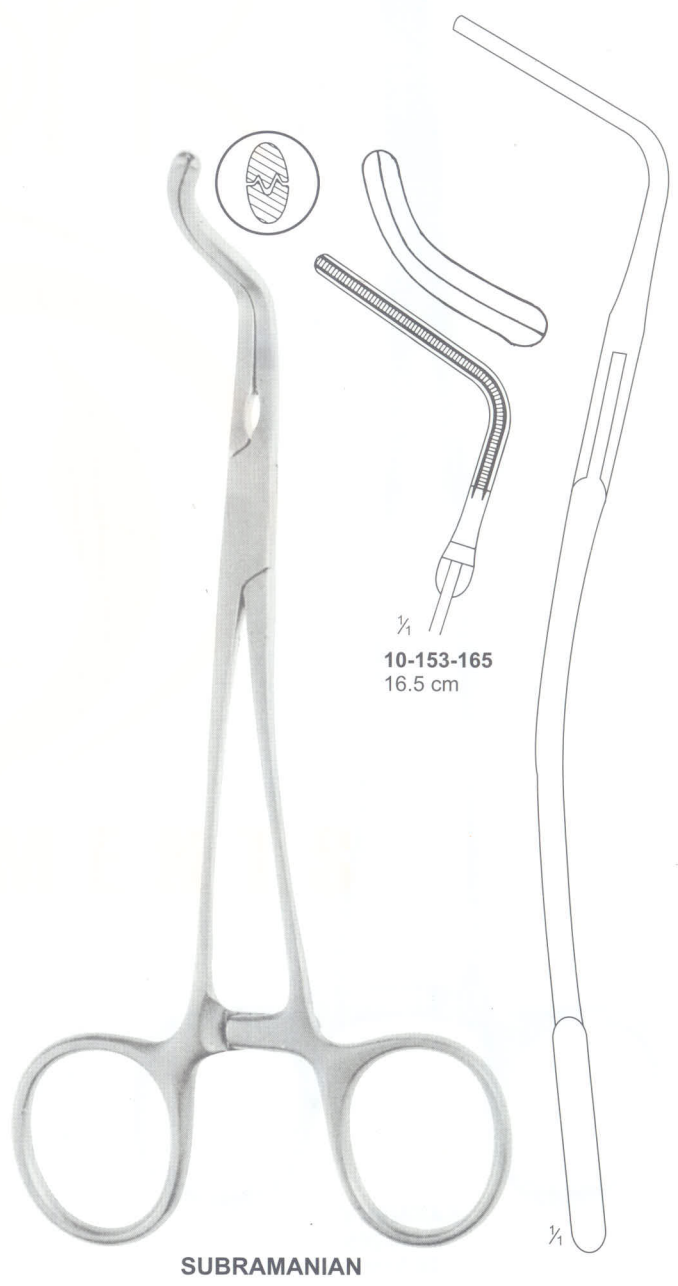
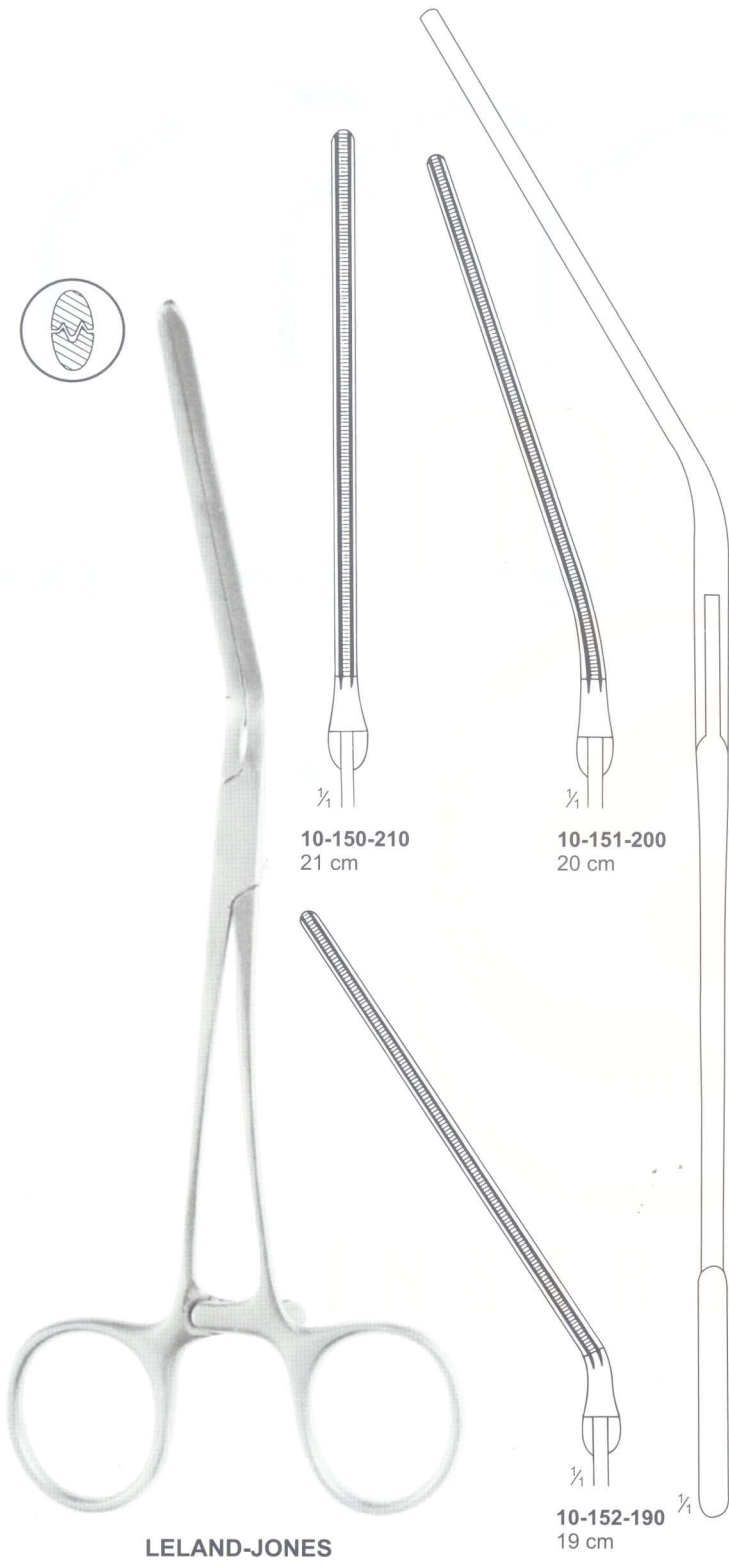

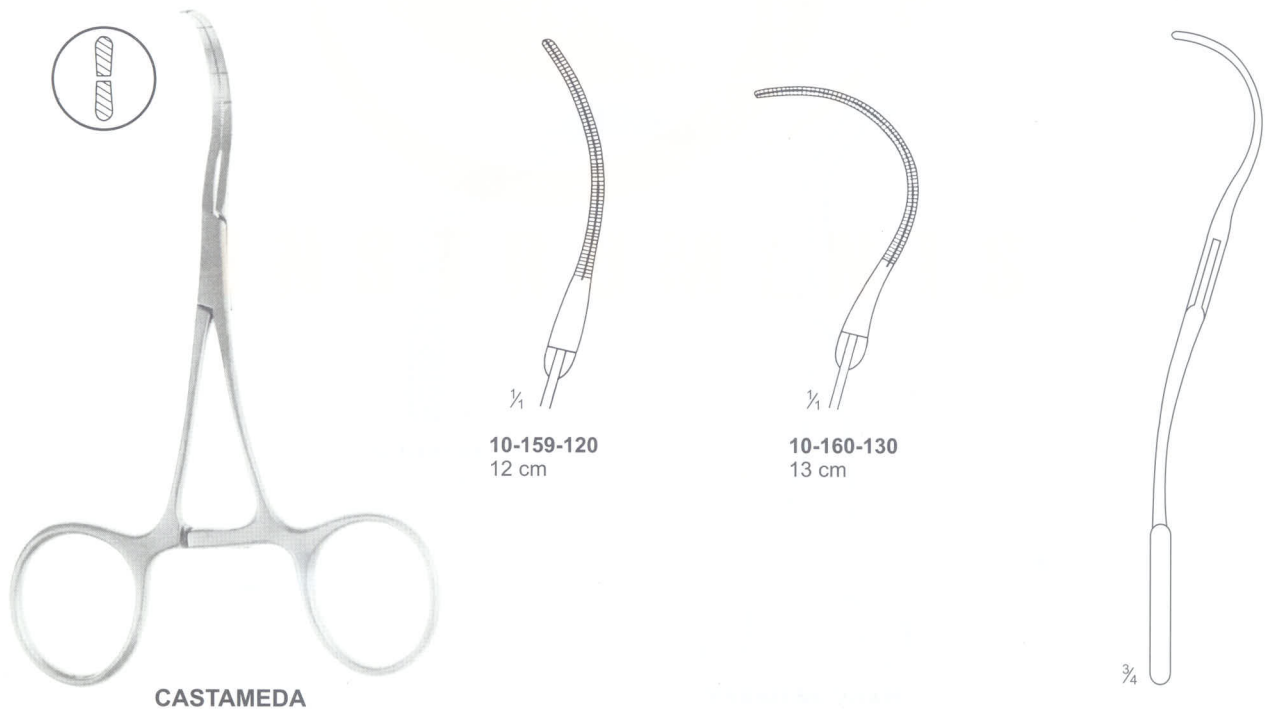



**PRICE-THOMAS**  
22 cm



**10-161-220**  
22 cm



**PRICE THOMAS**  
22 cm

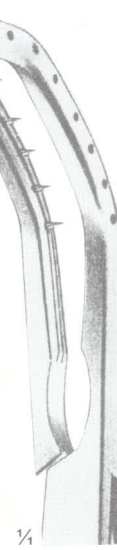

**10-162-220**  
jaw with pins

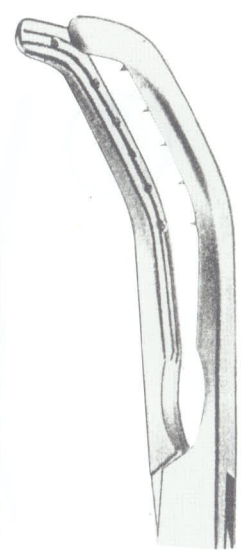

**10-163-220**  
jaw with pins



**BABY-SATINSKY**

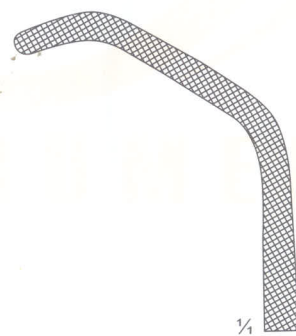

**10-164-150**  
15 cm

# THORACIC/CARDIOVASCULAR



**BAILEY-GIBBON**  
10-165-200  
20 cm  
For Adult



¼  
**10-166-200**  
20 cm  
For children

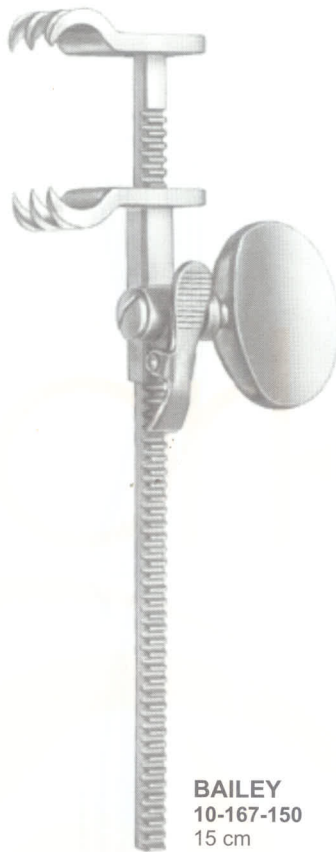

**BAILEY**  
10-167-150  
15 cm



**SELLORS RIB CONTRACTOR**  
10-168-200  
20 cm

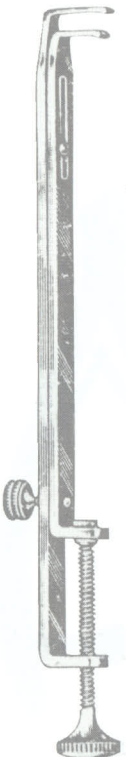

**BLALOCK**

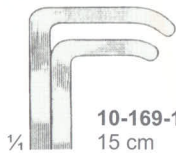

¼  
**10-169-150**  
15 cm

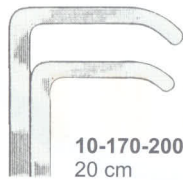

**10-170-200**  
20 cm

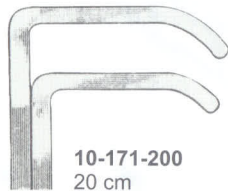

**10-171-200**  
20 cm



**JOHNS-HOPKINS  
(POTTS Modif.)**

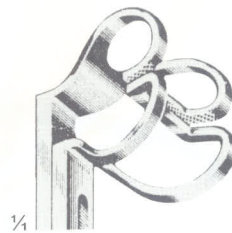

¼  
**10-172-200**  
20 cm

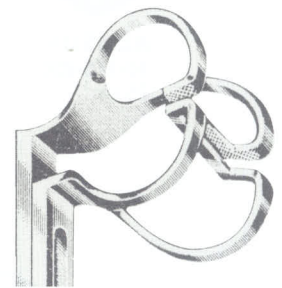

**10-173-200**  
20 cm

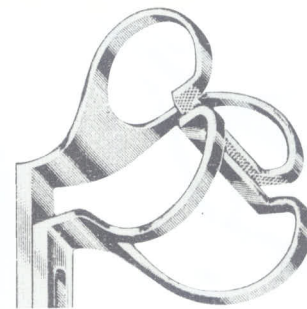

**10-174-200**  
20 cm



**ALLISON**  
10-175-250  
25 cm

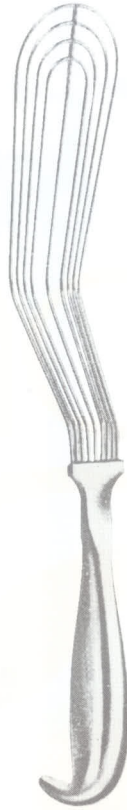

**ALLISON**  
10-176-320  
32 cm

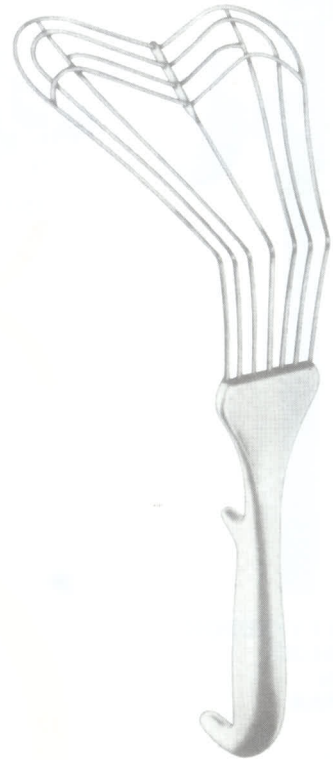

**10-177-300**  
30 cm



**TUBBS**  
10-178-00  
Blade Opening  
From 8 To 42 mm

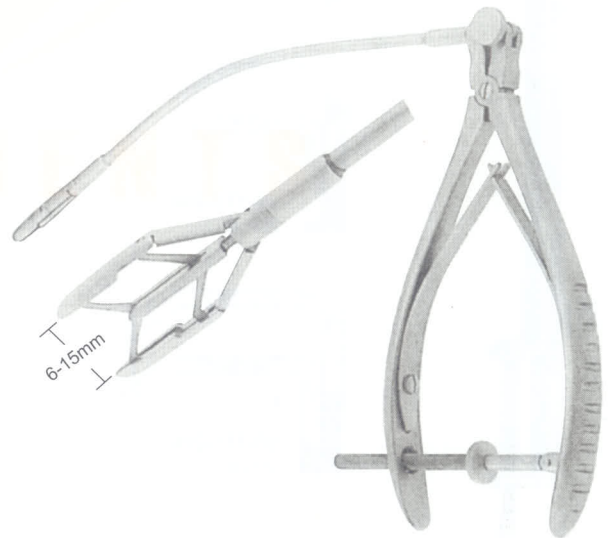

**COOLEY**  
10-179-00  
Blade Opening  
From 8 To 15 mm



**NABATOFF**  
**10-180-000**  
 varicose vein probe  
 set complete



**10-181-000**  
 Plastic Probe tip



**10-182-000**  
 3 mm Ø  
 Olive



**10-183-000**  
 6 mm Ø  
 Olive



**10-184-000**  
 9 mm Ø  
 Olive

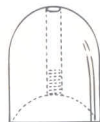

**10-185-000**  
 12 mm Ø  
 Olive

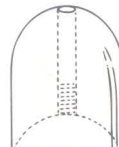

**10-186-000**  
 15 mm Ø  
 Olive

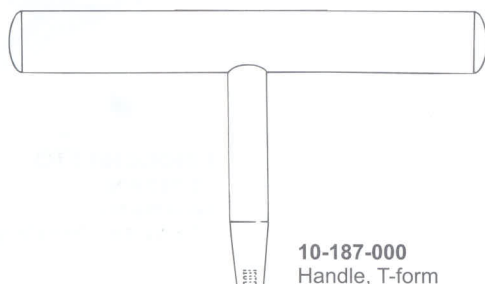

**10-187-000**  
 Handle, T-form



**TRACTION CABLE**  
**10-188-000**





**COOLEY**  
10-189-000  
lateral blades  
12 x 16 mm  
spreading 95 mm



**COOLEY**  
10-190-000 lateral blades 15 x 30 m, spreading 140 mm  
10-191-000 lateral blades 21 x 44 m, spreading 150 mm



**COOLEY**  
10-192-000  
lateral blades  
35 x 50 mm,  
spreading 300 mm

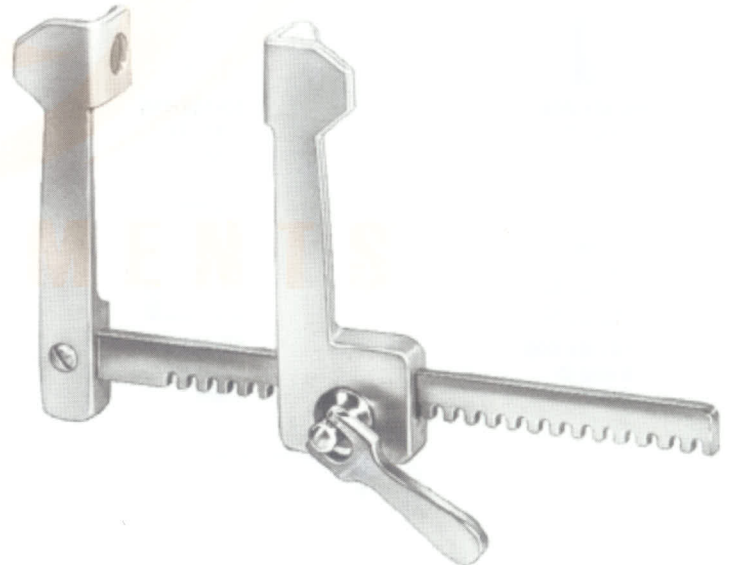

**FINOCCHIETTO,**  
10-193-000  
lateral blades  
15 x 15 mm, spreading 75 mm

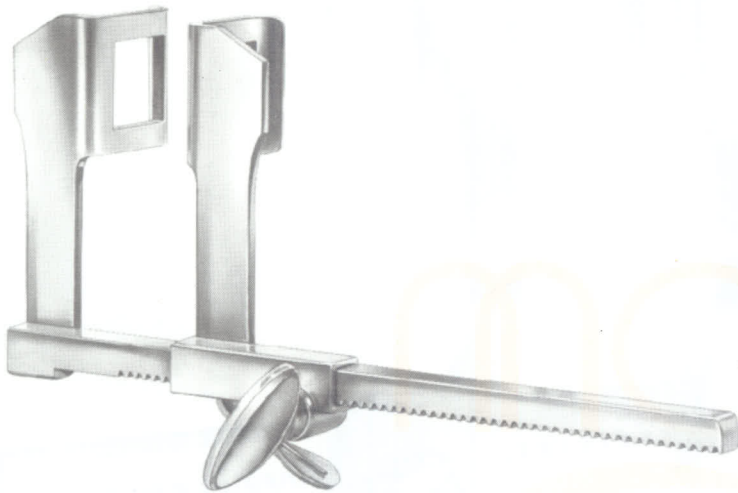

**HAIGHT**  
10-194-000  
lateral blades 30 x 30 mm,  
spreading 120 mm

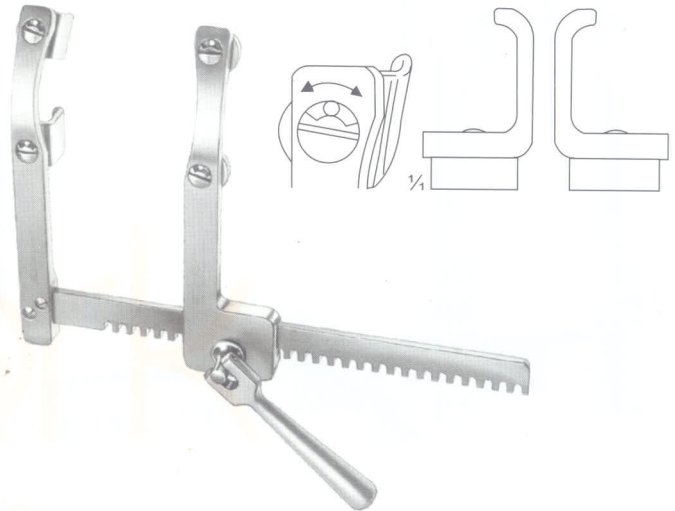

**MORSE-FAVALORO STERNAL**  
10-195-000  
4 movable blades 17 x 22 mm,  
spreading 160mm for children

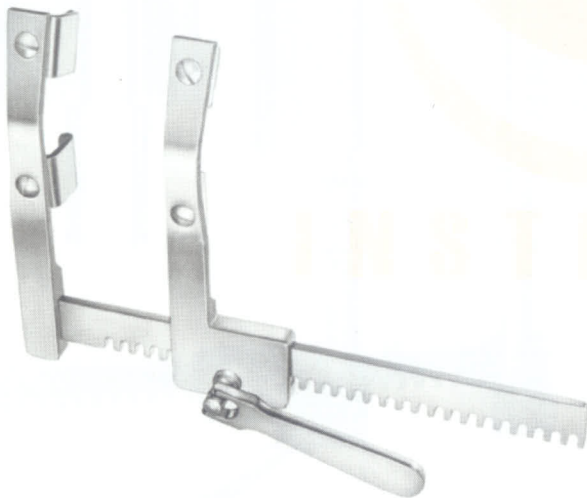

**MORSE STERNAL**  
10-196-000  
4 movable blades 27 x 22 mm,  
spreading 200 mm for adults



**TUFFIER RIB**  
10-197-000  
lateral blades 45 x 45 mm,  
spreading 160 mm

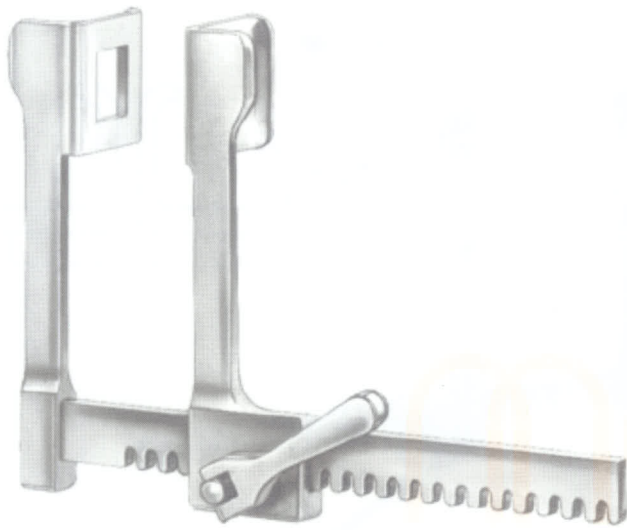

**FINOCCHIETTO, BABY**  
10-198-000  
lateral blades 14 x 15 mm,  
spreading 75 mm



**FINOCCHIETTO,**  
10-199-000 lateral blades 30 x 45 mm, spreading 150 mm  
10-200-000 lateral blades 46 x 62 mm, spreading 190 mm  
10-201-000 lateral blades 80 x 65 mm, spreading 190 mm



**THORACIC**  
10-202-000 Complete set  
with 1 pairs of blades

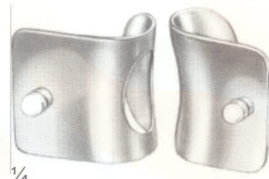

1/4  
10-203-000  
48 x 68 mm  
pair



1/4  
10-204-000  
70 x 75 mm  
pair

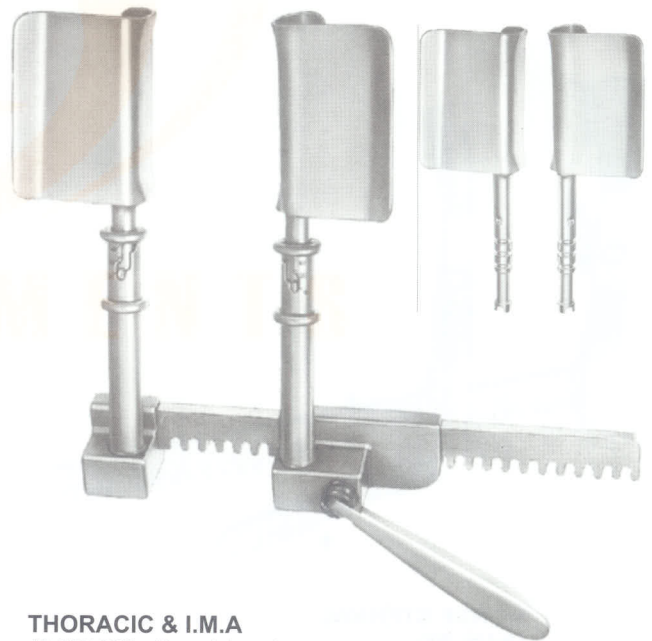

**THORACIC & I.M.A**  
10-205-000 Complete set  
10-206-000 lateral blades for I.M.A Retractor  
left 40 x 50 x 80 mm  
10-207-000 lateral blades for I.M.A Retractor  
Right 40 x 50 x 80 mm



**BURFORD / FINOCCHIETTO,**  
**10-208-180**  
18 cm  
spread with 2 sets of Blades  
65 mm x 62 mm  
47 mm x 62 mm



**SAUERBRUCH-FREY**  
10-209-370  
for the first rib  
37 cm

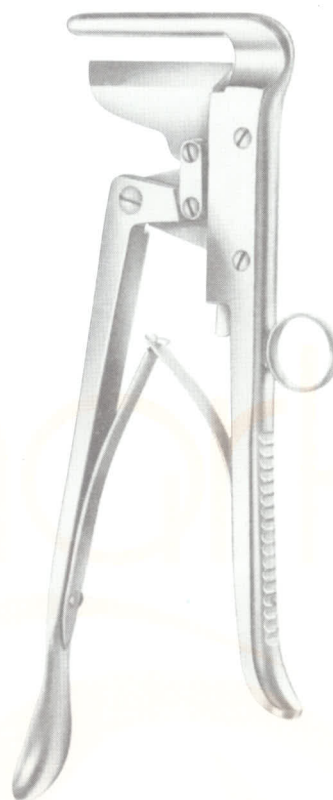

**SCHUMACHER**  
10-210-210  
sternum shears  
21 cm



**BONE SHEAR**  
10-211-230  
23 cm



**RIB SHEAR**  
10-212-230  
23 cm



**GLUCK**  
10-213-210  
21 cm



**LEBSCHE  
STERNUM CHISEL**  
10-214-245  
24.5 cm

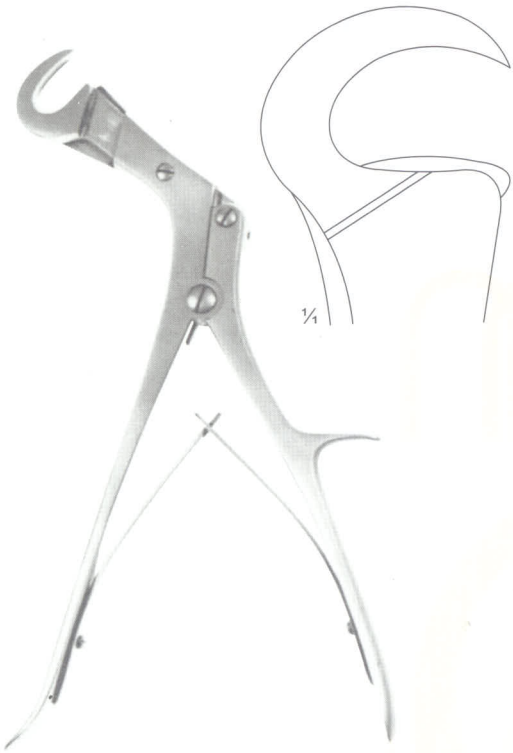

**GIERTZ-SEMB**  
10-215-280  
28 cm

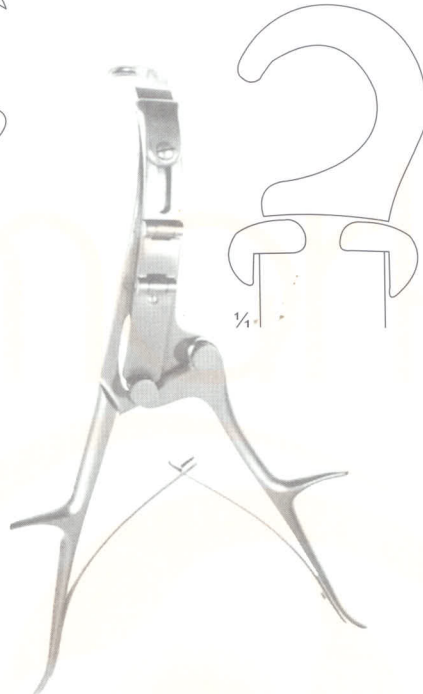

**BRUNNER**  
10-216-335  
33.5 cm

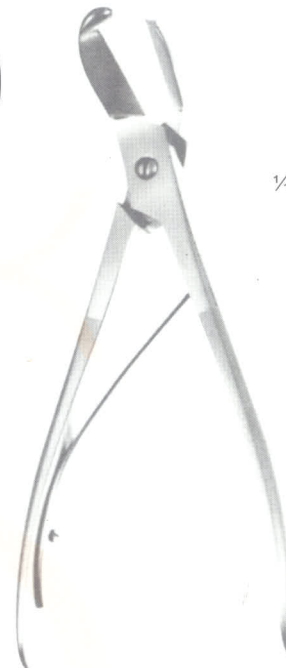

**MAURER-COLLIN**

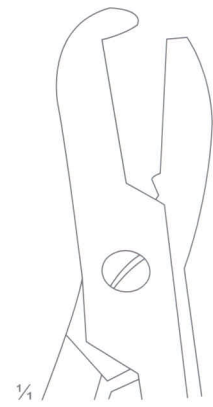

**10-217-230**  
Hooked Left  
23 cm



**10-218-230**  
Hooked Right  
23 cm

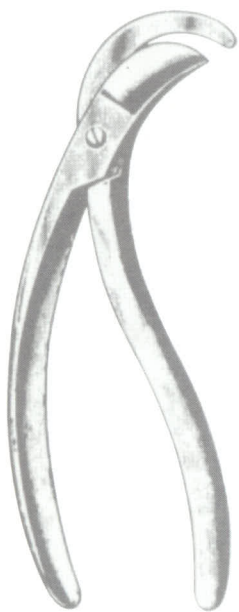

**COLLIN**  
10-219-190  
19 cm

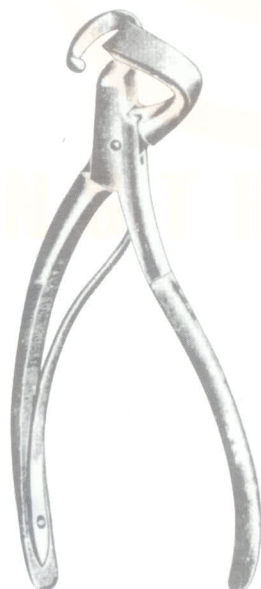

**DOYEN**  
10-220-190  
19 cm



**SAUERBRUCH**  
10-221-240 24 cm For Children,  
10-222-270 27 cm For Adults,



**SCHUARDT**  
10-223-170  
17 cm