

Gallensteiniöfel
Gall Stone Scoops
Curettes pour calculs biliaires
Cucharas para cálculos biliares
Pinze per calcoli biliari

PROFIT[®]
Surgical Instruments



federn
elásticas
élastiques
elásticas
elástico



62.180.17



62.180.21



62.180.24



62.180.27

<u>cm</u>	<u>DESJARDINS</u>
30,0	62.180.17
30,0	62.180.21
30,0	62.180.24
30,0	62.180.27

Gallensteintöffel
 Gall Stone Scoops
 Curettes pour calculs biliaires
 Cucharas para cálculos biliares
 Pinze per calcoli biliari

PROFIT[®]
 Surgical Instruments

biegsam
 malleable
 souples
 maleables
 malleabili



62.190.01
 32 cm
 Fig. 000



62.190.02
 32 cm
 Fig. 00



62.190.03
 32 cm
 Fig. 0



62.190.04
 32 cm
 Fig. 1



62.190.05
 32 cm
 Fig. 2



62.190.06
 32 cm
 Fig. 3



62.190.07
 32 cm
 Fig. 4



62.190.08
 32 cm
 Fig. 5

Fig	mm	LUER-KOERTE
000	Ø 2,5	62.190.01
00	Ø 3,2	62.190.02
0	Ø 4,2	62.190.03
1	Ø 5,5	62.190.04
2	Ø 6,7	62.190.05
3	Ø 8,0	62.190.06
4	Ø 11,0	62.190.07
5	Ø 15,0	62.190.08

Ureterklemmen
Ureter Clamps
Pincés-clapms uretère
Pinzas clamps para ureter
Pinze per uretere

PROFIT[®]
Surgical Instruments



cm MAYO
32,0 62.210.32



cm LURZ
21,0 62.221.21



cm LURZ
21,0 62.223.21

Mastdarm
Rectum
Rectum
Recto
Retto



BUJE
68.261.41
41 cm

Biopsie-Zangen
Biopsy Specimen Forceps
Pinces emporte-pièce à biopsie
Pinzas sacabocado para biopsia
Pinze per biopsia

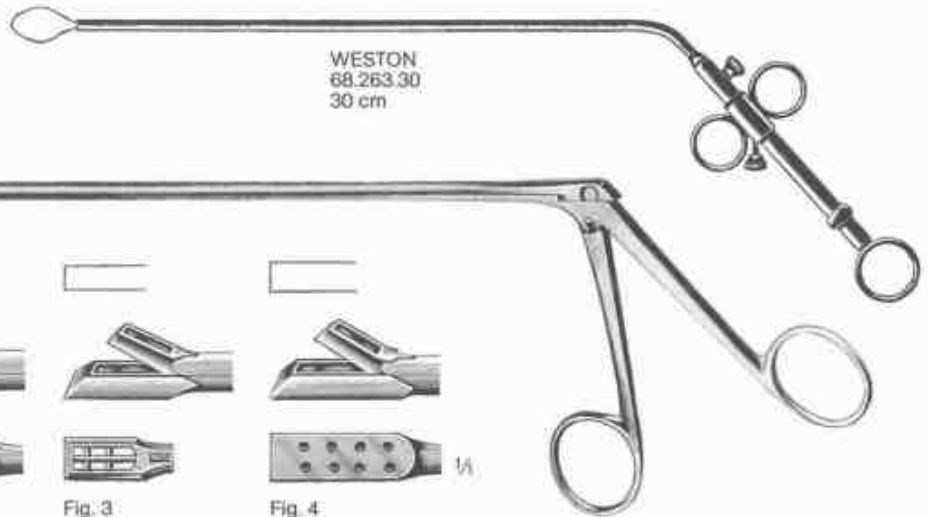

WESTON
68.263.30
30 cm

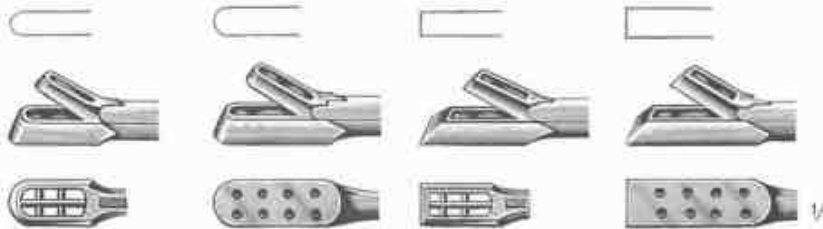

Fig. 1

Fig. 2

Fig. 3

Fig. 4

				cm	YEOMAN
68.301.28	68.302.28	68.303.28	68.304.28	28	
68.301.35	68.302.35	68.303.35	68.304.35	35	
68.301.42	68.302.42	68.303.42	68.304.42	42	



drehbar
rotatable
rotative
giratoria
girevole

cm	YEOMAN
23	68.311.23
33	68.311.33
40	68.311.40



drehbar
rotatable
rotative
giratoria
girevole

cm	TURREL
23	68.321.23
33	68.321.33
40	68.321.40

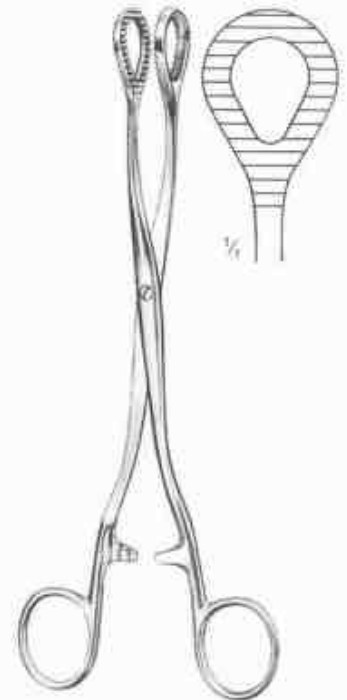

HEYWOOD-SMITH
68.402.21
21 cm

Vaginalspekula
 Vaginal Specula
 Speculums vaginaux
 Espécules vaginales
 Specoli vaginali



GRAVE			
Fig.	mm	Standard	Laser Mod.
1	75x20	70.110.01	70.114.01
2	95x35	70.110.02	70.114.02
3	115x35	70.110.03	70.114.03



GRAVE		
Fig.	mm	Standard
2	95x35	70.111.02

mit Absaugung
 with suction
 avec aspiration
 con aspiradoras
 con aspirazione



extra klein
 extra small
 extra petit
 extra pequeno
 extra piccolo

GRAVE
 70.112.01
 76 x 12 mm



extra groß
 extra large
 extra grande
 extra grande
 extra grande

GRAVE
 70.112.02
 120 x 38 mm

Vaginalspekula
Vaginal Specula
Speculum vaginaux
Espécules vaginales
Specoli vaginali

PROFIT[®]
Surgical Instruments



PEDERSON

Fig.	mm	
1	75x13	70.120.01
2	100x22	70.120.02
3	120x25	70.120.03



PEDERSON
70.122.10
100 x 31 mm

Vaginalspekula
 Vaginal Specula
 Speculums vaginaux
 Espécules vaginales
 Specoli vaginali

PROFIT[®]
 Surgical Instruments



COLLIN		
Fig.	mm	
1	85x30	70.130.01
2	100x35	70.130.02
3	110x40	70.130.03



COLLIN
70.131.00
 65x20 mm



COLLIN
70.132.00
 65x10 mm



Seitl. Schraube
 Lateral Screw
 Vis latérale
 Tornillo lateral
 Vite laterale

CUSCO			
Fig.	mm	Standard	Laser Mod.
0	80x24	70.140.00	
1	75x32	70.140.01	
2	85x35	70.140.02	70.144.02
3	100x35	70.140.03	70.144.03

Vaginalspekula
Vaginal Specula
Speculums vaginaux
Espécules vaginales
Specoli vaginali

PROFIT[®]
Surgical Instruments



CUSCO
70.142.00
75x17 mm

Mittelschraube
Central Screw
Vis centrale
Tornillo central
Vite centrale



CUSCO	mm
70.150.00	80x24
70.150.01	75x32
70.150.02	85x36
70.150.03	95x37
70.150.04	110x37
70.151.00	75x17

Vaginatspekula
 Vaginal Specula
 Speculum vaginaux
 Espécules vaginales
 Specoli vaginali

PROFIT[®]
 Surgical Instruments

flache Entenschnabelform
 flat duck beak
 plat bec de canard
 pico de pato llano
 becco d'anatra piatto



CUSCO	mm
70.152.01	80x32
70.152.02	90x37
70.152.03	115x37

Schweizer Modell
 Swiss Pattern
 Modèle suisse
 Modelo suizo
 Modello svizzero



Fig.	mm	CUSCO
1	90x23-25	70.160.01
2	100x25-27	70.160.02
3	110x27-30	70.160.03



FREEWAY GRAVE
70.162.01
 100 x 32 mm



FREEWAY GRAVE
70.162.02
 45°

Vaginālspekula
Vaginal Specula
Speculums vaginaux
Espécules vaginales
Specoli vaginali

PROFIT[®]
Surgical Instruments



mm	TRELAT
85x33	70.180.01
95x35	70.180.02
115x43	70.180.03



mm	SEMM
90x14-18	70.190.00
100x17-20	70.190.01
100x25-30	70.190.02

Vaginalspekula, Scheidenhalter
Vaginal Specula, Vaginal Retractors
Speculums vaginaux, Valves vaginales
Espéculos vaginales, Valvas vaginales
Specoli vaginali, Valve vaginali

PROFIT[®]
Surgical Instruments



O'SULLIVAN O'CONNOR
70.196.00
komplett
complete
complet
completo
completo



70.196.01
Fig. 1
45x17 mm

70.196.02
Fig. 2
90x37 mm

70.196.03
Fig. 3
90x45mm

Vaginalspekula, Scheidenhalter
 Vaginal Specula, Vaginal Retractors
 Speculums vaginaux, Valves vaginales
 Espécules vaginales, Valvas vaginales
 Specoli vaginali, Valve vaginali



	Satz Fig. set no. jeu no. juego no. serie no.	bestehend aus: consisting of se composant de consiste de composto da
KRISTELLER		
70.210.00	0	70.211.00 + 70.212.00
70.210.01	1	70.211.01 + 70.212.01
70.210.02	2	70.211.02 + 70.212.02
70.210.03	3	70.211.03 + 70.212.03

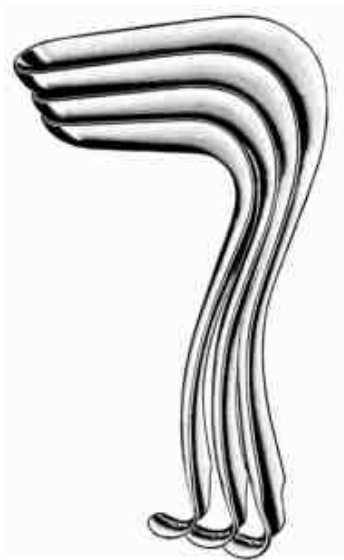

Fig.	mm	KRISTELLER
0	70x15	70.211.00
1	70x27	70.211.01
2	80x30	70.211.02
3	90x36	70.211.03

Spekulum
 Speculum
 Spéculum
 Espéculo
 Specolo



Fig.	mm	KRISTELLER
0	75x10	70.212.00
1	75x23	70.212.01
2	85x26	70.212.02
3	100x32	70.212.03

Halter
 Retractor
 Valve
 Valva

Vaginalspekula, Scheidenhalter
 Vaginal Specula, Vaginal Retractors
 Speculums vaginaux, Valves vaginales
 Espéculos vaginales, Valvas vaginales
 Specoli vaginali, Valve vaginali



Mit konischen Blättern, für Jungfrauen
 With taper blades, for virgins
 A valves coniques, pour vierges
 Con hojas cónicas, para vírgenes
 Con valve coniche, per vergini

Satz Fig.
 set no.
 jeu no.
 juego no.
 série no.

bestehend aus
 consisting of
 se composant de
 consiste de
 composto da

KRISTELLER

70.220.01	1	70.221.01 + 70.222.01
70.220.02	2	70.221.02 + 70.222.02

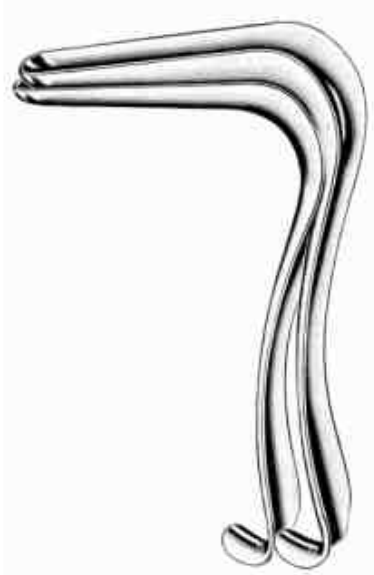

mm	KRISTELLER
105x18	70.221.01
105x21	70.221.02

Spekulum
 Speculum
 Spéculum
 Espéculo
 Specolo



mm	KRISTELLER
110x14	70.222.01
115x17	70.222.02

Halter
 Retractor
 Valve
 Valva

Vaginalspekula, Scheidenhalter
 Vaginal Specula, Vaginal Retractors
 Speculums vaginaux, Velves vaginales
 Espéculos vaginales, Valvas vaginales
 Specoli vaginali, Valve vaginali



KRISTELLER

	Satz Fig. set no. jeu no. juego no. serie no.	bestehend aus consisting of se composant de consiste de composto da
70.230.01	1	70.231.01 + 70.232.01
70.230.02	2	70.231.02 + 70.232.02
70.230.03	3	70.231.03 + 70.232.03

Flache Specula
 Specula Flat Hollow
 Spéculums plats
 Espéculos con huecos planos
 Specoli piatti

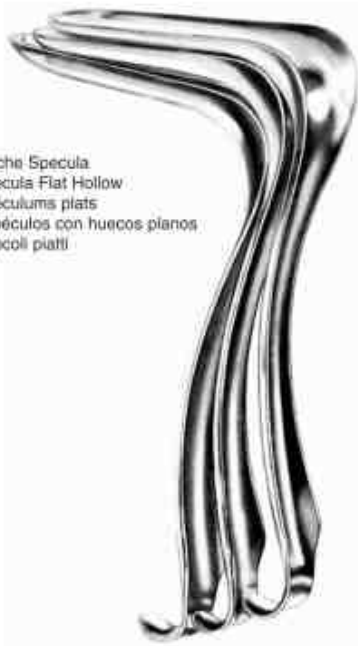

KRISTELLER	Fig.	mm
70.231.01	1	105 x 26
70.231.02	2	105 x 25
70.231.03	3	105 x 33

Spekulum
 Spéculum
 Spéculum
 Espéculo
 Specolo



KRISTELLER	Fig.	mm
70.232.01	1	115 x 22
70.232.02	2	115 x 24
70.232.03	3	115 x 29

Halter
 Retractor
 Valve
 Valva

Vaginālspekūla, Scheidenhalter
 Vaginal Specula, Vaginal Retractors
 Speculums vaginaux, Velves vaginales
 Espécules vaginales, Valvas vaginales
 Specoli vaginali, Valve vaginali



	Satz Fig. set no. jeu no. juego no. serie no.	bestehend aus consisting of se composant de consiste de composto da
KRISTELLER		
70.239.99	00	70.239.97 + 70.239.98
70.240.00	0	70.241.00 + 70.242.00
70.240.01	1	70.241.01 + 70.242.01
70.240.02	2	70.241.02 + 70.242.02
70.240.03	3	70.241.03 + 70.242.03

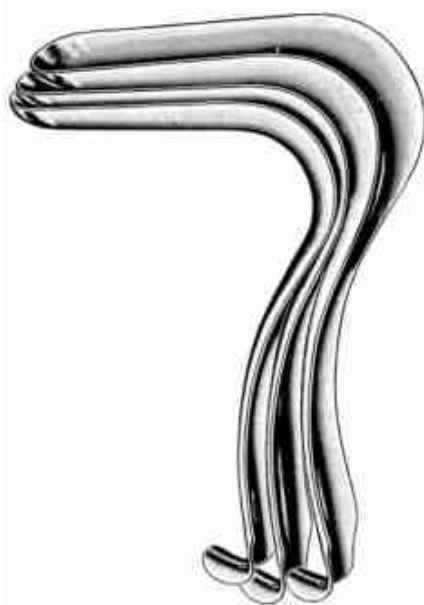

Fig.	mm	KRISTELLER
00	110x18	70.239.97
0	110x20	70.241.00
1	110x27	70.241.01
2	110x30	70.241.02
3	110x36	70.241.03

Spekulum
 Speculum
 Spéculum
 Espéculo
 Specolo

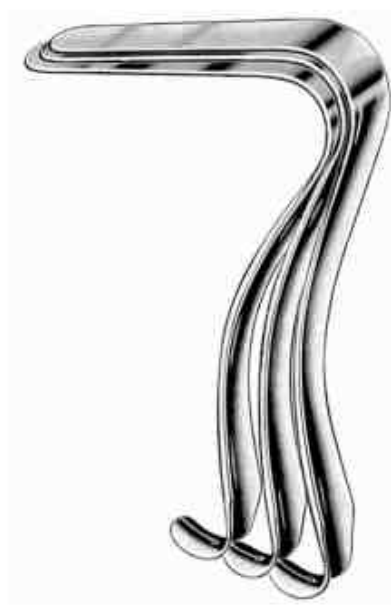

Fig.	mm	KRISTELLER
00	115x14	70.239.98
0	115x17	70.242.00
1	115x23	70.242.01
2	115x26	70.242.02
3	115x32	70.242.03

Halter
 Retractor
 Valve
 Valva

Vaginalspekula, Scheidenhalter
 Vaginal Specula, Vaginal Retractors
 Speculum vaginaux, Velves vaginales
 Espécules vaginales, Valvas vaginales
 Specoli vaginali, Valve vaginali



Für Kinder
 For children
 Pour enfants
 Para niños
 Per bambini

Satz Fig.
 set no.
 jeu no.
 juego no.
 serie no.

bestehend aus
 consisting of
 se composant de
 consiste de
 composto de

KRISTELLER
 70.244.00

0

70.245.00 + 70.246.00



KRISTELLER
 mm
 70x15 **70.245.00**

Spekulum
 Speculum
 Spéculum
 Espéculo
 Specolo



KRISTELLER
 mm
 75x10 **70.246.00**

Halter
 Retractor
 Valve
 Valva

Vaginalspekula, Scheidenhalter
 Vaginal Specula, Vaginal Retractors
 Speculums vaginaux, Velves vaginales
 Espéculos vaginales, Valvas vaginales
 Specoli vaginali, Valve vaginali



KRISTELLER
70.250.00

Satz Fig.
 set no.
 jeu no.
 juego no.
 serie no.

0

bestehend aus
 consisting of
 se compoartit de
 consiste de
 composto da

70.251.00 + 70.252.00



mm **KRISTELLER**
 135x36 **70.251.00**

Spekulum
 Speculum
 Spéculum
 Espéculo
 Specolo



mm **KRISTELLER**
 140x30 **70.252.00**

Halter
 Retractor
 Valve
 Valva

Vaginalspekula, Scheidenhalter
 Vaginal Specula, Vaginal Retractors
 Speculums vaginaux, Velves vaginales
 Espéculos vaginales, Valvas vaginales
 Specoli vaginali, Valve vaginali



Setz Fig.
 set no.
 jeu no.
 juego no.
 serie no.

bestehend aus:
 consisting of
 se compostant de
 consiste de
 composto da

KALLMORGEN

70.260.01	1	70.261.01	70.262.01
70.260.02	2	70.261.02	70.262.02



mm	KALLMORGEN
70x40	70.261.01
90x40	70.261.02
Spekulum	
Speculum	
Spéculum	
Espéculo	
Specolo	



mm	KALLMORGEN
70x33	70.262.01
90x33	70.262.02
Halter	
Retractor	
Valve	
Valva	

Vaginalspekula
 Vaginal Specula
 Speculums vaginaux
 Espécules vaginales
 Specoli vaginali

PROFIT[®]
 Surgical Instruments

56 x 13 mm



mm	BRAUN
56x13	70.263.01

60 x 10 mm



mm	BRAUN
60x10	70.264.01



flaches Spekulum
 flat speculum
 spéculum plat
 espéculo plano
 specchio piatto

JACKSON



70.271.01
 75 x 40 mm



70.271.02
 80 x 40 mm



70.271.03
 100 x 40 mm

Vaginalspekula
 Vaginal Specula
 Speculums vaginaux
 Espécules vaginales
 Specoli vaginali



Fig. 1 = klein/small/petit/pequeno/piccolo
 Fig. 2 = mittel/medium/moyen/mediano/medio
 Fig. 3 = groß/large/grand/grande

SIMS		
Fig.	mm	
1	70x25	70.281.01
2	85x30	70.281.02
3	100x40	70.281.03

Scheidenspekula, doppelendig
 Vaginal specula, double-ended
 Spéculums vaginaux, doubles
 Espécules vaginales, doubles
 Speculi vaginali, doppi

70.291.00 = Set

bestehend aus
 consisting of
 consiste de
 se composant de
 composto da

70.291.01/70.291.02/70.291.03



Fig.	mm	SIMS
1	65x25, 70x30	70.291.01
2	70x30, 70x35	70.291.02
3	85x35, 90x40	70.291.03

Vaginalspekula
 Vaginal Specula
 Speculums vaginaux
 Espécules vaginales
 Specoli vaginali



leicht höhl
 slightly concave
 légèrement concave
 leggermente concavo
 leggermente concavo

Fig.	mm	DOYEN
1	75x45	70.300.01
2	90x45	70.300.02
3	110x45	70.300.03

Fig.	mm	DOYEN
1	55x35	70.301.01
2	75x35	70.301.02
3	115x35	70.301.03
1	55x45	70.303.01
2	75x45	70.303.02
3	115x45	70.303.03
4	160x45	70.303.04
1	55x60	70.305.01
2	75x60	70.305.02
3	115x60	70.305.03
4	160x60	70.305.04

Vaginālspekula
Vaginal Specula
Speculums vaginaux
Espéculos vaginales
Specoli vaginali

PROFIT[®]
Surgical Instruments



AUVARD
70.307.00
83x38 mm
Loses Gewicht
Detachable Weight
Poids démontable
Pesa desmontable
Peso smontabile

AUVARD
70.309.00
83 x 38 mm
Festes Gewicht
Fixed Weight
Poids fixe
Pesa fija
Peso fiso

Vaginalspekula
Vaginal Specula
Speculums vaginaux
Espéculos vaginales
Specoli vaginali

PROFIT[®]
Surgical Instruments



mm	BREISKY
100x20	70.310.20
100x25	70.310.25
100x30	70.310.30
100x35	70.310.35
100x40	70.310.40
130x20	70.313.20
130x25	70.313.25
130x30	70.313.30
130x35	70.313.35
130x40	70.313.40
155x40	70.315.40



DOYEN
70.317.24
25,0 cm

Vaginalspekula
 Vaginal Specula
 Speculum vaginaux
 Espéculos vaginales
 Specoli vaginali



SCHERBAK

70.318.00

Satz komplett mit Griff,
 Gewicht (400 g) und 5 Blättern
 complete Set with handle,
 weight (400 g) and 5 blades
 jeu complet avec manche,
 poids (400 g) et 5 valves
 juego completo con mango,
 peso (400 g) y 5 valvas
 Set completo con manico,
 peso (400 g) e 5 valve

Blatt allein
 Specula Blade only
 Valve vaginale, seule
 Valva vaginal, suelta
 Valve vaginale, sola



SCHERBAK

70.318.01	80x30 mm
70.318.02	85x35 mm
70.318.03	90x40 mm

SCHERBAK

70.318.04	62x40-60 mm
70.318.05	81x45-70 mm

Gewicht zum Vaginalspekulum
 Weight for Vaginal Speculum
 Poids pour spéculum vaginal
 Peso para especulo vaginal
 Peso per specolo vaginale



SCHERBAK

70.318.10
 10,5 cm
 400 g

SCHERBAK

70.318.12
 13,0 cm
 800 g



Griff zum Vaginalspekulum
 Handle for Vaginal Speculum
 Manche pour spéculum vaginal
 Mango para especulo vaginal
 Manico per specolo vaginale

SCHERBAK

70.318.14
 20,0 cm

Vaginalspekula
Vaginal Specula
Speculums vaginaux
Espéculos vaginales
Specoli vaginali

PROFIT[®]
Surgical Instruments



LANDAU
70.319.28 100x28 mm
70.319.38 100x38 mm



70.320.99
Auffangsieb
Strainer for Vaginal Speculum
Tamis pour spéculum vaginal
Tamiz para especulo vaginal
Crivello per specolo vaginale

WEISSBARTH
70.320.24
80x42 mm
komplett, mit abnehmbarem Auffangkorb
complete, with detachable strainer
complet avec tamis démontable
completo, con tamiz desmontable
completo con crivello smontabile

Endospekula
 Endocervical Specula
 Endospéculums
 Espéculos endocervicales
 Endospecoli

PROFIT[®]
 Surgical Instruments



FRIEDMANN
 70.351.10 10,0 cm
 70.351.15 15,0 cm

mit skaliertem Sperre und Fixierschraube
 with graduated ratchet and fixing screw
 avec crémaillère à échelle et vis à fixation
 con cremallera graduada y tornillo de fijación
 con cremagliera con scala e vite di fissaggio



KOGAN
 70.359.24
 24,5 cm



Standard	KOGAN	Laser
70.360.24	24,0 cm	70.364.24

Uterusdilatoren
Uterine Dilators
Dilateurs du col de l'utérus
Dilatores uterinos
Dilatatori uterini

PROFIT[®]
Surgical Instruments



GOODELL
70.441.34
34,0 cm



WYLIE
70.443.29
29,0 cm

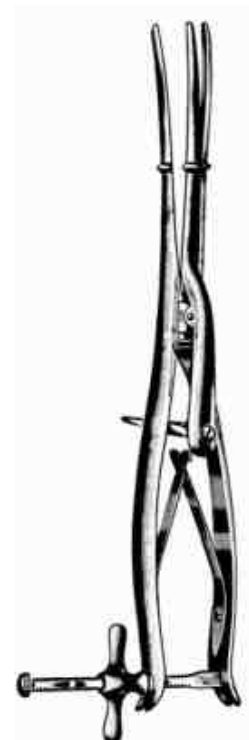

SIMS
70.445.29
29,0 cm

Hakenzangen
 Tenaculum Forceps
 Pinces pour abaissement du col de l'utérus
 Pinzas para coger el cuello del útero
 Pinze per abbassare il collo dell'utero

PROFIT[®]
 Surgical Instruments



2x2 Zähne
 2x2 teeth
 2x2 dents
 2x2 dientes
 2x2 denti

JAKOBS
70.532.21
 21,0 cm



2x2 Zähne
 2x2 teeth
 2x2 dents
 2x2 dientes
 2x2 denti

JAKOBS
70.533.21
 21,0 cm



2x3 Zähne
 2x3 teeth
 2x3 dents
 2x3 dientes
 2x3 denti

HENROTIN
70.534.20
 20,5 cm



4x4 Zähne
 4x4 teeth
 4x4 dents
 4x4 dientes
 4x4 denti

PRATT
70.536.28
 28,0 cm



4x4 Zähne
 4x4 teeth
 4x4 dents
 4x4 dientes
 4x4 denti

CZERNY
70.537.21
 21,0 cm



4x4 Zähne
 4x4 teeth
 4x4 dents
 4x4 dientes
 4x4 denti

BRAUN
70.538.15
 15,5 cm

Uterus-Polypenzangen
Uterine Polypus Forceps
Pincas à polípes uterins
Pinzas para pólipos uterinos
Pinze per polipi uterine

PROFIT[®]
Surgical Instruments



NOTO
70.540.27
27,0 cm



DOYEN
70.542.20
20,0 cm



KELLY
70.543.32
32,0 cm

Uterus-Faßzangen
Uterine Elevating Forceps
Pinces hystérolabes
Pinzas para el útero
Pinzas per afferrare l'utero

PROFIT[®]
Surgical Instruments



DARTIGUES
70.545.27
27,0 cm



SOMER
70.547.23
23,0 cm



COLLIN
70.549.25
25,0 cm



COLLIN
70.550.28
28,0 cm

Uterus-Faßzangen
Uterine Elevating Forceps
Pinces hystérolabes
Pinzas para el útero
Pinzas per afferrare l'utero

PROFIT[®]
Surgical Instruments

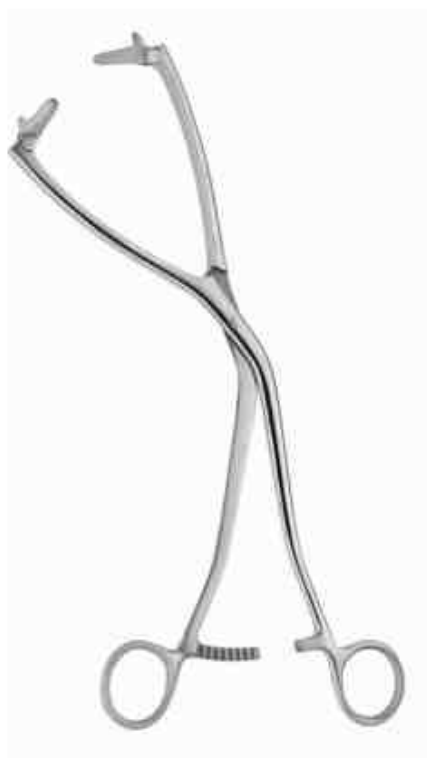

COLLIN
70.551.25
25,0 cm



BUMM
70.552.28
28,0 cm



SIEGLER HELLMANN
70.553.24
24,0 cm

Uterussonden, Uterusdepressor
 Uterine Sounds, Uterine Depressor
 Hystéromètres, Dépresseur utérin
 Histerómetros, Depresor uterino
 Isterometri, Depressore uterino



Anniatom
 Anniatome
 Anniotome
 Anniótomo
 Anniotomo

BEACHMANN
70.559.26
 26 cm



BRAUN
70.565.28
 28 cm



Uterus-Depressoren
 Uterine Depressors
 Dépresseurs utérins
 Depresores uterinos
 Depressori uterini

SIMS
70.567.26
 26 cm



starr
 rigid
 rigida
 rigida
 rigida

SIMS
70.580.32
 32 cm

Uterus-Sonden
 Uterine Sounds
 Hystéromètres
 Histerómetros
 Isterometri



starr
 rigid
 rigida
 rigida
 rigida

MARTIN
70.582.32
 32 cm



biegsam
 malleable
 malleable
 malleable
 malleable

COLLIN
70.584.28
 28 cm



biegsam
 malleable
 malleable
 malleable
 malleable

VALLEIX
70.585.25
 29,5 cm

Uterus-Biopsie-Saugküretten
 Uterine Biopsy Aspirating Curettes
 Curettes aspirantes à biopsie de l'utérus
 Curetas aspiradoras p. la biopsia uterina
 Curette di aspirazione per biopsia

PROFIT[®]
 Surgical Instruments



RANDALL
70.590.04
 24 cm/4 mm



mm	NOVAK
1	70.592.01
2	70.592.02
3	70.592.03
4	70.592.04



mit Korb
 with basket
 avec grille
 con cesto
 con cestino

KEVORKIAN		
70.594.12	1,2 mm	
70.594.40	4,0 mm	70.596.40
	30 cm	

Probeexcisionszangen
Biopsy Specimen Forceps
Pincas amporte-pièce pour le col de l'utérus
Pinzas sacabocado para el cuello del útero
Pinze taglianti per biopsia

PROFIT[®]
Surgical Instruments



FAURE
70.601.21
21 cm



cm	SCHUBERT
21	70.604.21
28	70.604.28

SCHUBERT
70.605.26
26 cm

Biopsiezangen
Biopsy Specimen Forceps
Pincas à biopsia
Pinzas sacabocado p. biopsia
Pinze per biopsia

PROFIT[®]
Surgical Instruments



THOMS-GAYLOR
70.606.21 23,5 cm
70.606.24 21,0 cm



GELLHORN
70.609.23
23 cm



van DOREN
70.611.25
25 cm

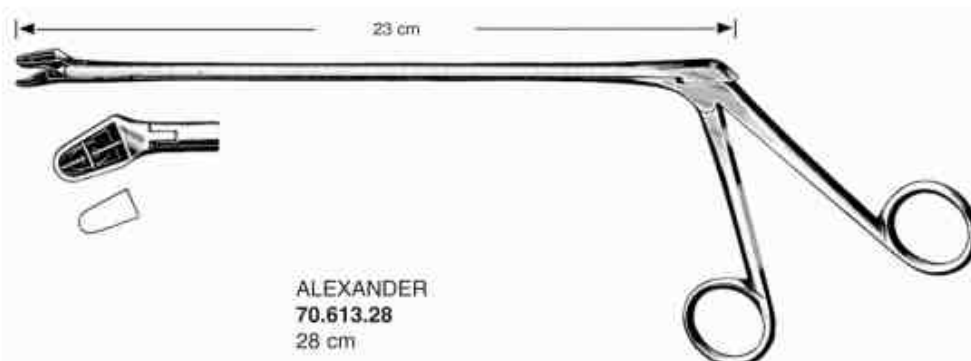

ALEXANDER
70.613.28
28 cm

Biopsiezangen
 Biopsy Specimen Forceps
 Pinces à biopsie
 Pinzas sacabocado p. biopsia
 Pinze per biopsia

PROFIT[®]
 Surgical Instruments

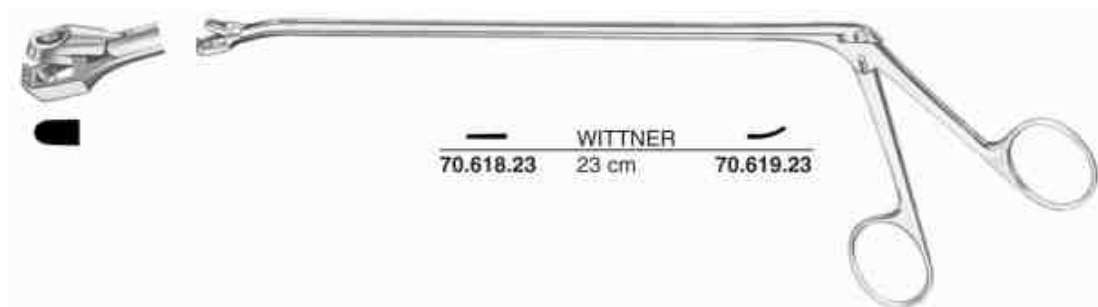
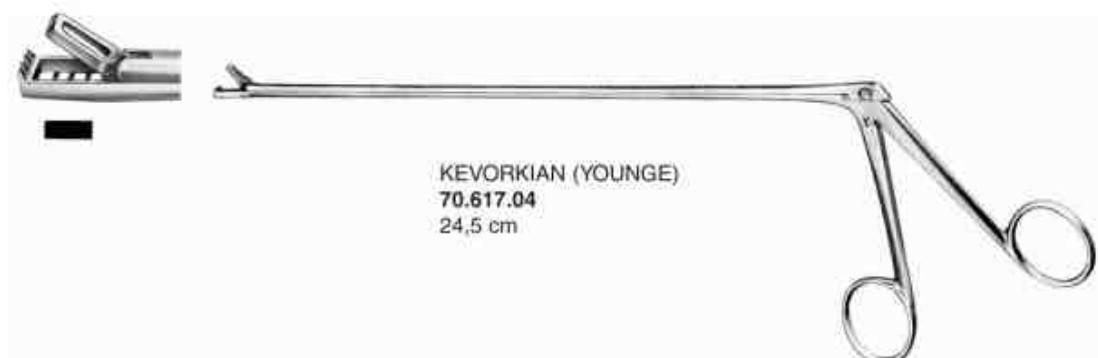

Biopsiezangen
 Biopsy Specimen Forceps
 Pincas à biopsie
 Pinzas sacabocado p. biopsia
 Pinze per biopsia

PROFIT[®]
 Surgical Instruments



oval
 7 x 5 mm

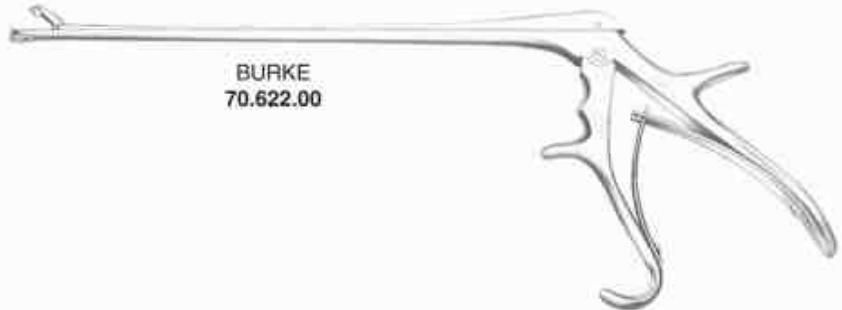

BURKE
 70.622.00



Fig. 1
TISCHLER Morgan



Fig. 3
 oval ● 3,7 x 5 mm



Fig. 5
 mini



Fig. 4
KEVORKAN



■ 3 x 8 mm



	Instr. kompl. compl. instr. Instrum. compl. Strumento completo	Aufsatz allein Tip only Embout seul Punta sola
Fig.	TOWNSEND	
1	70.624.01	70.624.11
3	70.624.03	70.624.13
4	70.624.04	70.624.14
5	70.624.05	70.624.15

70.624.99
 Griff allein
 handle only
 manche seul
 manico solo
 mango suelto



KEVORKIAN-Pacific
 70.625.04

Biopsiezangen
Biopsy Specimen Forceps
Pincas à biopsie
Pinzas sacabocado p. biopsia
Pinze per biopsia

PROFIT[®]
Surgical Instruments



■ 2,3 x 4,2 mm



TOWNSEND-MINI (BABY TISCHLER)
70.626.00



■ 3,0 x 9,5 mm



TISCHLER-KEVORKIAN
70.627.00



● 4,0 x 6,5 mm



BAGGISH
70.628.00



■ 4,5 x 8 mm

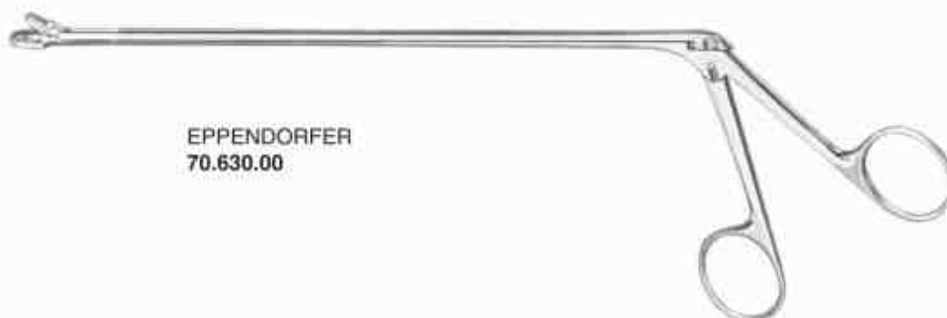

EPPENDORFER
70.630.00

Biopsiezangen
 Biopsy Specimen Forceps
 Pinces à biopsie
 Pinzas sacabocado p. biopsia
 Pinze per biopsia

PROFIT[®]
 Surgical Instruments

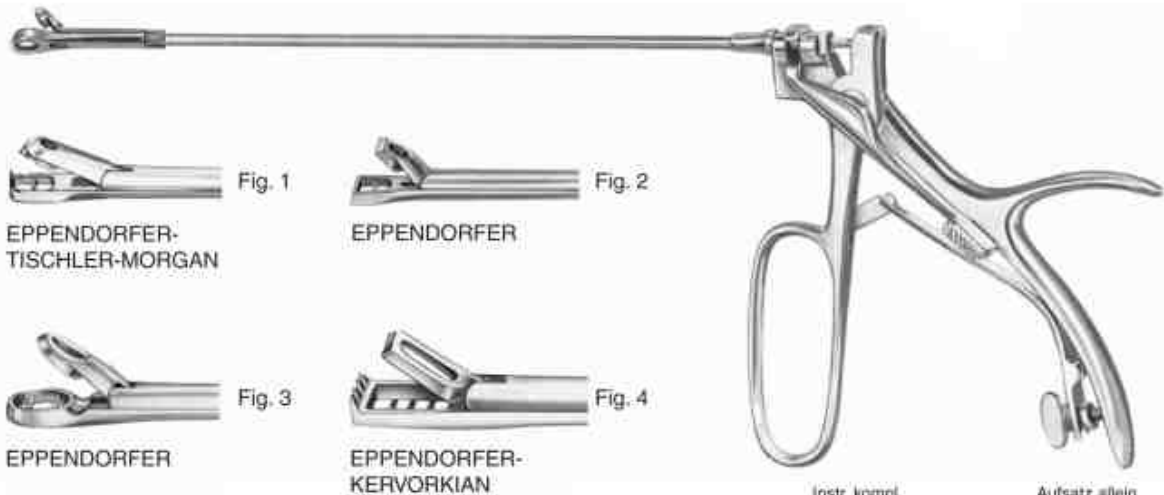

EPPENDORFER-TISCHLER-MORGAN

EPPENDORFER

EPPENDORFER

EPPENDORFER-KERVORKIAN

Fig.	Instr. kompl. compl. instr. Instrumento completo	Aufsatz allein Tip only Embout seul Punta sola
1	70.632.01	70.632.11
2	70.632.02	70.632.12
3	70.632.03	70.632.13
4	70.632.04	70.632.14

Myom-Heber
 Myoma Screw
 Tracteur pour fibromes
 Tirabuzón para fibromas
 Tiramioni



DOYEN
 70.641.17
 15 cm

Myommesser
 Myoma knives
 Evidens pour fibromes
 Cuchillo para fibromas
 Bisturi per fibromi



SEGOND
 70.643.27
 27 cm



EMMET
 22 cm

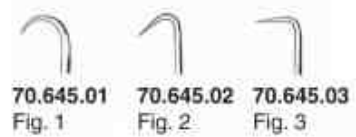

70.645.01 Fig. 1 70.645.02 Fig. 2 70.645.03 Fig. 3



70.645.04 Fig. 4 70.645.05 Fig. 5

Fistelhaken
 Fistula Hooks
 Crochets pour fistules
 Ganchos para fistulas
 Uncini per fistole

Salpingograph
 Salpingograph
 Salpingographe
 Salpingógrafo
 Salpingografe

PROFIT[®]
 Surgical Instruments

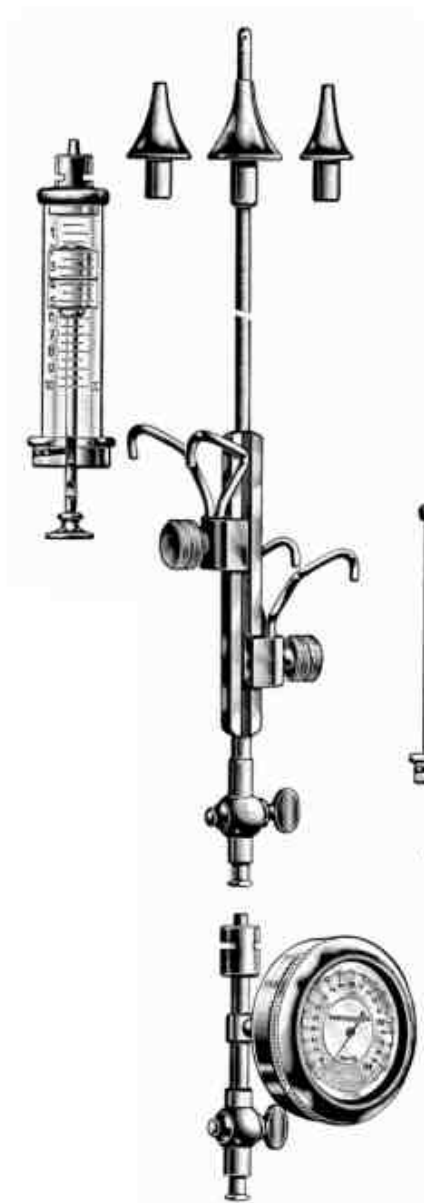

SCHULTZE
70.650.00
 compl.

im Holzetui
 in wooden case
 en boîte de bois
 en estuche de madera
 in scatola di legno



SCHULTZE
70.650.01

ohne Manometer
 without manometer
 sans manomètre
 sin manómetro
 senza manometro



SCHULTZE
70.650.10

Manometer zum Salpingograph
 Manometer for Salpingograph
 Manomètre pour salpingographe
 Manómetro para salpingógrafo
 Manometro per salpingografo

Uteruslöffel, -kürette
 Uterine Curettes
 Curettas utérines
 Curetas uterinas
 Curetta uterine

PROFIT[®]
 Surgical Instruments

scharf
 sharp
 tranchant
 cortante
 tagliente



Fig.	SIMON
1	70.702.01
2	70.702.02
3	70.702.03
4	70.702.04
5	70.702.05
6	70.702.06
	25 cm



Fig.	SCHROEDER
1	70.703.01
2	70.703.02
3	70.703.03
4	70.703.04
5	70.703.05
6	70.703.06
	31 cm



scharf/stumpf
 sharp/blunt
 tranchant/mousse
 cortante/roma
 tagliente/smussa

BLAKE
70.704.27
 27 cm



Fig.	GOURDET
1	70.706.01
2	70.706.02
3	70.706.03
4	70.706.04
5	70.703.05
	28 cm

Uterus-Küretten
 Uterine Curettes
 Curettes utérines
 Curetas uterinas
 Curette uterine

PROFIT[®]
 Surgical Instruments

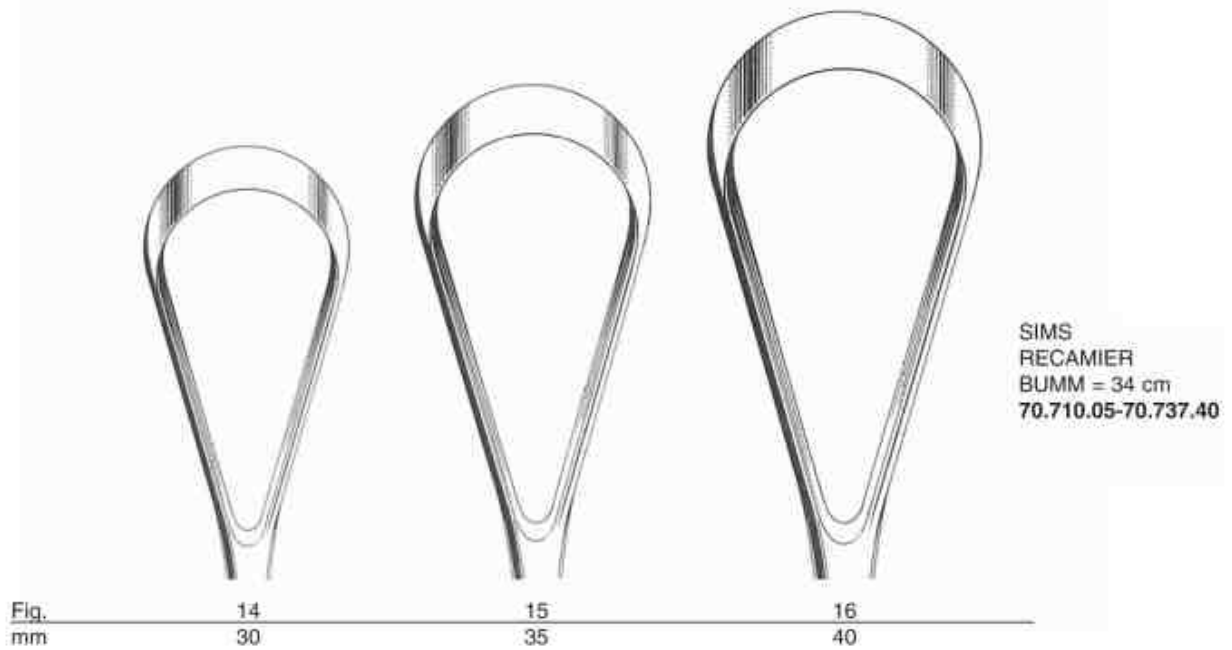
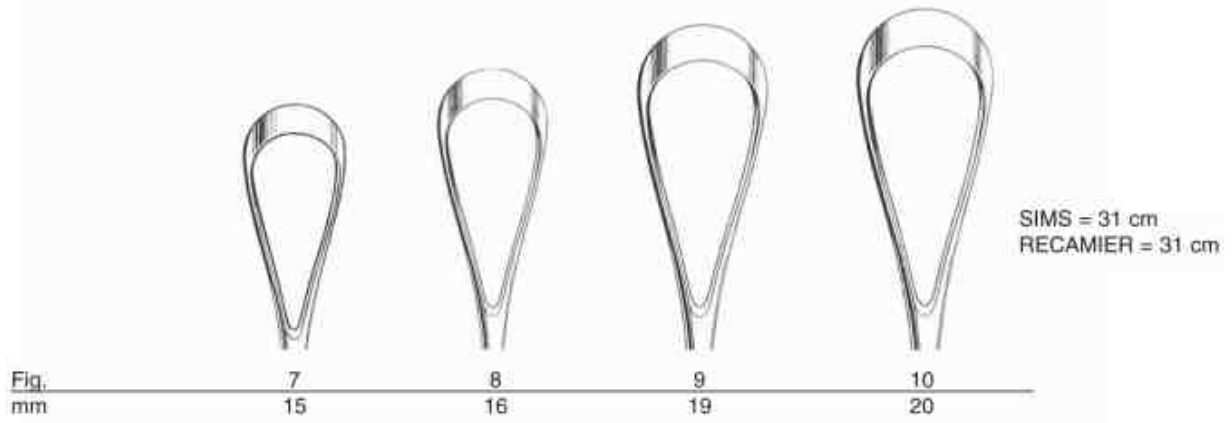
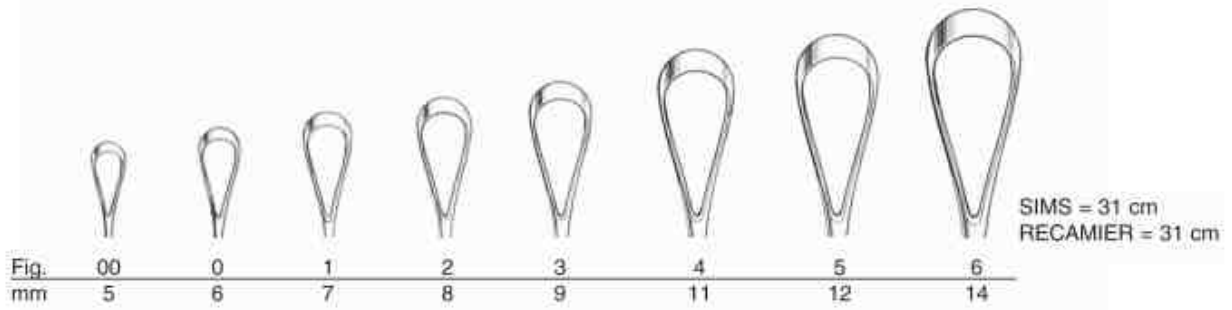

Uterus-Küretten
 Uterine Curettes
 Curettes utérines
 Curetas uterinas
 Curette uterine

PROFIT[®]
 Surgical Instruments



SIMS
 70.710.05-70.717.14
 31 cm



RECAMIER
 70.720.07-70.727.25
 31 cm



BUMM
 70.730.30-70.737.40
 34 cm

Ausführung	scharf	stumpf
Features	sharp	blunt
Exécution	tranch.	mousse
Ejecución	cut.	roma
Esecuzione	tagli.	smussa
fest./rig.	A.	B.
flex./fless.	C.	D.

Fig.	A	B	C	D	A	B	C	D	A	B	C	D
00	70.710.05	70.712.05	70.715.05	70.717.05	70.720.05	70.722.05	70.725.05	70.727.05				
0	70.710.06	70.712.06	70.715.06	70.717.06	70.720.06	70.722.06	70.725.06	70.727.06				
1	70.710.07	70.712.07	70.715.07	70.717.07	70.720.07	70.722.07	70.725.07	70.727.07				
2	70.710.08	70.712.08	70.715.08	70.717.08	70.720.08	70.722.08	70.725.08	70.727.08				
3	70.710.09	70.712.09	70.715.09	70.717.09	70.720.09	70.722.09	70.725.09	70.727.09				
4	70.710.11	70.712.11	70.715.11	70.717.11	70.720.11	70.722.11	70.725.11	70.727.11				
5	70.710.12	70.712.12	70.715.12	70.717.12	70.720.12	70.722.12	70.725.12	70.727.12				
6	70.710.14	70.712.14	70.715.14	70.717.14	70.720.14	70.722.14	70.725.14	70.727.14				
7					70.720.15	70.722.15	70.725.15	70.727.15				
8					70.720.16	70.722.16	70.725.16	70.727.16				
9					70.720.19	70.722.19	70.725.19	70.727.19				
10					70.720.20	70.722.20	70.725.20	70.727.20				70.737.28
14									70.730.30	70.732.30	70.735.30	70.737.30
15									70.730.35	70.732.35	70.735.35	70.737.35
16									70.730.40	70.732.40	70.735.40	70.737.40

Absaugküretten
 Suction Curettes
 Curettes d'aspiration
 Curetas aspiradoras
 Curette per aspirazione



70.810.50
 Kupplungsstück
 Coupling Piece
 Pièce de raccordement
 Pieza de acoplamiento
 Pezzo di collegamento

29 cm

70.810.03	Ø 3,0 mm
70.810.04	Ø 4,0 mm
70.810.06	Ø 6,0 mm
70.810.08	Ø 8,0 mm
70.810.10	Ø 10,0 mm
70.810.12	Ø 12,0 mm
70.810.14	Ø 14,0 mm



Tubenfaßpinzette
 Tubal-seizing forceps
 Pinces a saisir les trompes
 Pinza para sostener trompas
 Pinze per afferare trompe

NEUBÜSSER

20 cm

70.850.06	Ø 6,0 mm
70.850.08	Ø 8,0 mm
70.850.10	Ø 10,0 mm

Geburtszangen
 Obstetrical Forceps
 Forceps obstétriques
 Fórceps obstétricos
 Forcipi obstetrici

Geburtszangen für section caesarea (Schnittentbindung)
 Forceps for caesarean section
 Forceps pour césarienne
 Fórceps para operación cesárea
 Forcipi per tagli cesarei



cm WRIGLEY
 23 72.101.23
 28 72.101.28



SIMPSON
 72.102.30
 30 cm



SIMPSON
 72.103.23
 23 cm

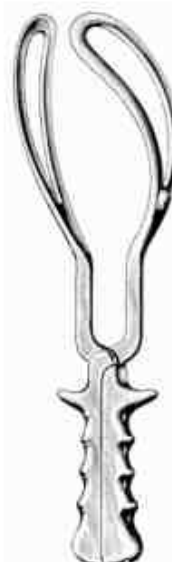

cm SIMPSON-BRAUN
 33 72.105.33
 36 72.105.36



De LEE
 72.107.30
 30 cm



cm De LEE
 36 72.108.36
 39 72.108.39



KIELLAND
 72.110.41
 41 cm



cm ELLIOT
 32 72.115.32
 38 72.115.38

Geburtszangen
 Obstetrical Forceps
 Forceps obstétriques
 Fórceps obstétricos
 Forcipi obstetrici

PROFIT[®]
 Surgical Instruments



cm	NAEGELE
36	72.119.36
40	72.119.40



LUIKART
 72.125.40
 40 cm



KIELLAND-LUIKART
 72.127.40
 40 cm



SIMPSON-LUIKART
 72.135.36
 36 cm



McLEAN-TUCKER-LUIKART
 72.139.40
 40 cm



McLEAN-TUCKER
 72.141.39
 39 cm



McLEAN-LUIKART
 72.143.39
 39 cm

Geburtszangen
 Obstetrical Forceps
 Forceps obstétriques
 Fórceps obstétricos
 Forcipi obstetrici

PROFIT[®]
 Surgical Instruments



McLEAN
 72.145.36
 36 cm



BARTON
 72.147.36
 36 cm



BARTON
 72.148.17
 17 cm



BOERMA
 72.151.29
 29 cm



PIPER
 72.155.44
 44 cm

für nachkommenden Kopf bei Steisslagen
 for delivery of the after coming head in breech presentation
 Spatules pour dégager la tête
 Especialmente para partos en presentación de nalgas
 Speciale in parti con presentazione di podice



PIPER
 72.157.40
 40 cm

Geburtszangen
 Obstetrical Forceps
 Forceps obstétriques
 Fórceps obstétricos
 Forcipi obstetrici

PROFIT[®]
 Surgical Instruments



DEWEY
 72.160.37
 37 cm



Geburtszange mit Achsenzugvorrichtung
 Forceps with traction rod
 Forceps avec dispositif de traction
 Fórceps con dispositivo de tracción
 Forcipi con dispositivo di trazione

TARNIER
 72.162.40
 40 cm

Kopfhobel für unteres Segment bei Kaiserschnitt
 Head extractor for use in lower segment in caesarean operation
 Levier à tête utilisé en cas de césarienne
 Elevador para cabeza usándose en le segmento inferior del útero
 en casos de operaciones cesáreas
 Elevatore per testa in interventi con taglio cesareo



MURLESS
 72.164.26

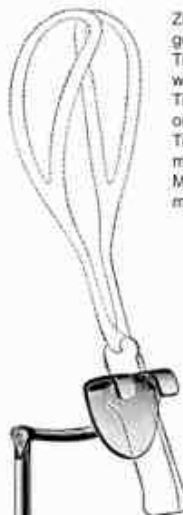

BILL
 72.170.00

Zughebel, passend für alle Geburtszangen mit
 gehobtem Standard-Griff
 Traction handle to be used with all forceps
 with standard type handle
 Tracteurs pour tous les forceps avec manches
 ordinaires
 Tractor adecuado para todas las fórceps con
 mango standard
 Manico a trazione adatto a tutte le forcipi con
 manico standard



LUIKART-BILL
 72.171.21
 21 cm



SMELLIE
 72.181.33
 33 cm



GAUSS
 72.183.27
 27 cm

Uterusklemmzange zur Blutstillung
 Caesarean section haemostatic forceps
 Pince-clamp utérine pour hémostase
 Pinza-clamp uterina para hemostasis
 Pinza emostatiche per tagli cesarei



GREEN-ARMYTAGE
 72.184.21
 21 cm

Nabelschnurklemmen
 Umbilical Cord Clamps
 Clamps p. cordon ombilical
 Clamps umbilicales
 Pinze ombelicali



COLLIN
 72.187.09
 9 cm



KANE
 72.189.09
 8,5 cm



MARTIN
 72.191.34
 34 cm



COLLIER
 72.193.30
 30 cm



COLLIN
 72.195.35
 35 cm

Plazentar- und Abortuszangen
 Placenta and Ovum Forceps
 Pinces placentaires et pour poste-abortum
 Pinzas para aborto y placenta
 Pinze per placenta e per ovaie

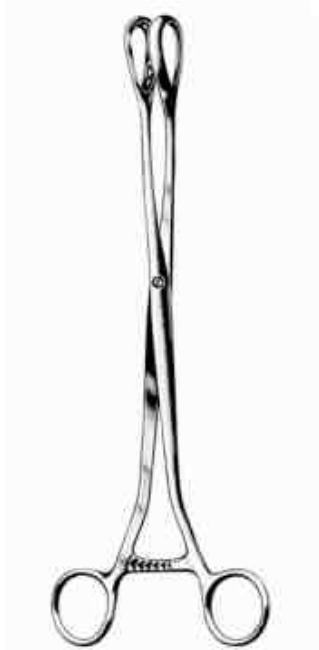

— SAENGER —
 72.242.27 72.243.27



— WINTER —
 28 cm
 Fig. 1 72.244.01 72.245.01
 2 72.244.02 72.245.02
 3 72.244.03 72.245.03



mit Sperre
 with ratchet
 avec crémaillère
 con cremallera
 con cremagliera

— WINTER — Fig.
 72.247.02 2
 72.247.03 3



— LEWKOWITZ —
 72.248.24 72.249.24



McCLINTOCK
 72.250.24
 24 cm

Plazentar- und Abortusöffel
 Placenta and ovum scoops
 Curettes à avortement et placenta
 Cucharillas para aborto y placenta
 Cucchiari per placenta e ovaie

PROFIT[®]
 Surgical Instruments

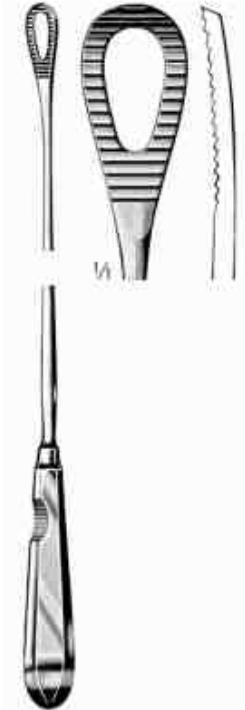

PESTALOZZA
 72.252.30
 30 cm



CUZZI
 72.254.14-72.254.21
 30 cm



72.254.14 72.254.18 72.254.21
 14,5 mm 18 mm 21 mm



WALLICH
 72.256.42
 42 cm

Geburtshilfe
 Obstetrics
 Accouchements
 Obstetricia
 Ostetricia

PROFIT[®]
 Surgical Instruments



SELLHEIM
 72.259.28
 28 cm



BRAUN
 72.302.42
 42 cm

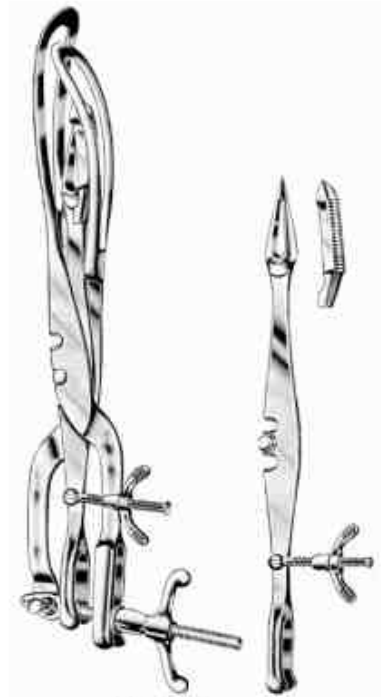

TARNIER
 72.304.46
 46 cm



Perforatorium
 Perforator
 Perce-crâne
 Perfora-crâneos
 Spezzacrânio

SMELLIE
 72.306.25
 25 cm



NÄGELE
 72.308.25
 25 cm



Decapitationshaken
 Decapitating hook
 Crochet pour décapitation
 Gancho para decapitación
 Uncino per detroncazione

BRAUN
 72.309.30
 30 cm



KILNER
 74.103.15
 15 cm



SCHAMBERG
 74.111.10
 10 cm

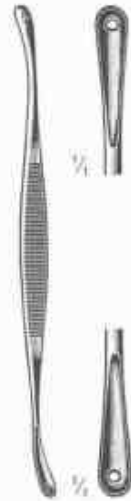

UNNA
 74.113.14
 14 cm

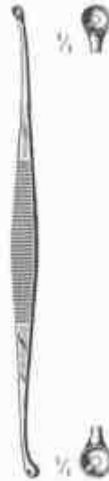

UNNA
 74.115.14
 14 cm



WALTON
 74.118.14
 14 cm



SAALFELD
 74.121.10
 10 cm

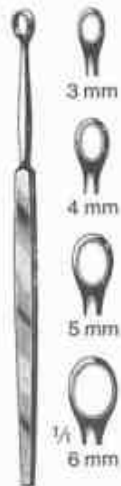

mm	FOX
3	74.128.03
4	74.128.04
5	74.128.05
6	74.128.06



Fig.	PIFFARD
1	74.130.01
2	74.130.02
3	74.130.03



KEYES
 74.138.00
 compl.

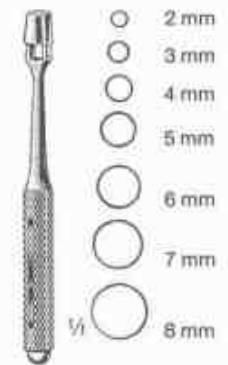

mm	KEYES
2	74.140.02
3	74.140.03
4	74.140.04
5	74.140.05
6	74.140.06
7	74.140.07
8	74.140.08

Hygiene
Hygiene
Hygiène
Higiene
Igiene



74.301.10

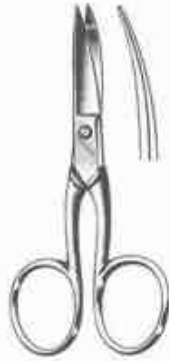

74.304.10 10 cm 74.305.10



74.331.14
14 cm



74.336.14
14 cm



cm TURNBULL
11,5 74.341.11
13,5 74.341.13



74.360.13
13 cm



74.365.11
11 cm



74.373.10
10,5 cm



74.378.10
10 cm



74.379.10
10 mm

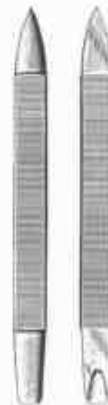

cm
10 74.386.10
12 74.386.12



74.396.00
10 Ersatzklingen
10 Spare Blades
10 lames de rechange
10 hojas de repuesto
10 lame di ricambio

CREDO
74.395.14
14,5 cm