

Arterienklemmen
 Hemostatic Forceps
 Pincès hémostatiques
 Pinzas hemostáticas
 Pinze emostatiche



Gefäßklemmen
 Serrefines
 Serre-fines
 Serra-finas
 Serrefine



cm	DIEFFENBACH		JOHNS-HOPKINS	
3,5	12.102.04	12.103.04		
5,0	12.102.05	12.103.05		
5,5			12.110.50	12.111.50
6,5			12.110.55	12.111.55
7,0			12.110.65	12.111.65
7,5			12.110.70	12.111.70
9,0			12.110.75	12.111.75
			12.110.90	12.111.90

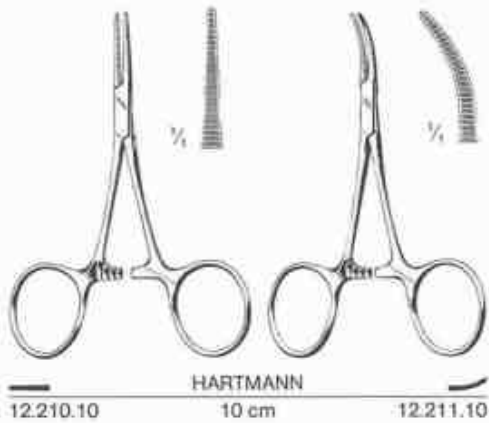

Arterienklemmen
 Hemostatic Forceps
 Pinces hémostatiques
 Pinzas hemostáticas
 Pinze emostatiche

PROFIT[®]
 Surgical Instruments

Titan
 Titanium
 Titane
 Titanio
 Titanio

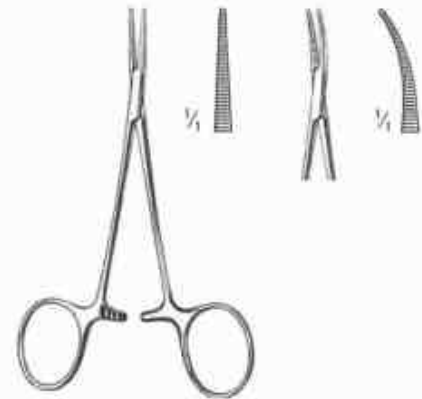

cm	— HALSTED - MOSQUITO —			— HALSTED - MOSQUITO micro —	
12,5	12.224.12	12.220.12	12.221.12	12.225.12	12.222.12
14,0		12.220.14	12.221.14		12.223.12
18,0		12.220.18	12.221.18		
21,0		12.220.21	12.221.21		

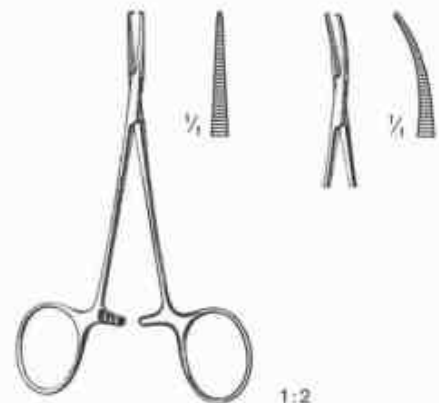

cm	— HALSTED - MOSQUITO —			— HALSTED - MOSQUITO micro —	
12,5	12.234.12	12.230.12	12.231.12	12.235.12	12.232.12
14,0		12.230.14	12.231.14		12.233.12
18,0		12.230.18	12.231.18		
21,0		12.230.21	12.231.21		

Arterienklemmen
 Hemostatic Forceps
 Pinces hémostatiques
 Pinzas hemostáticas
 Pinze emostatiche



Titan
 Titanium
 Titane
 Titanio
 Titanio

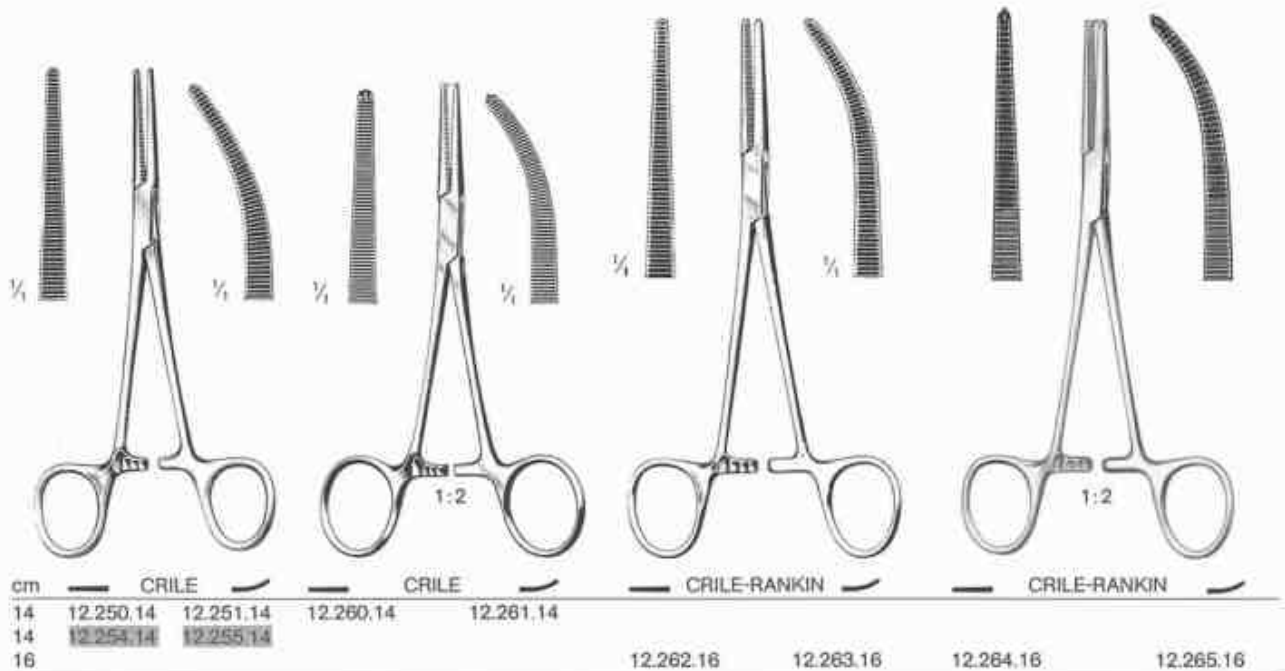
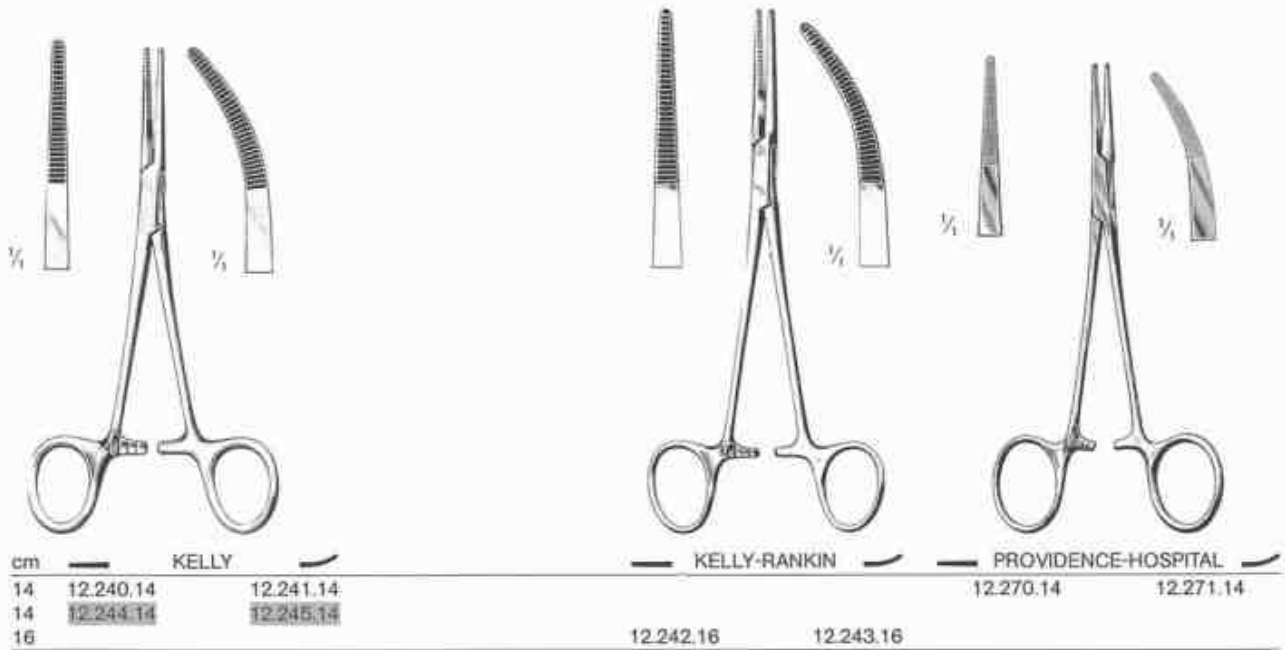

Arterienklemmen
 Hemostatic Forceps
 Pinces hémostatiques
 Pinzas hemostáticas
 Pinze emostatiche

PROFIT[®]
 Surgical Instruments

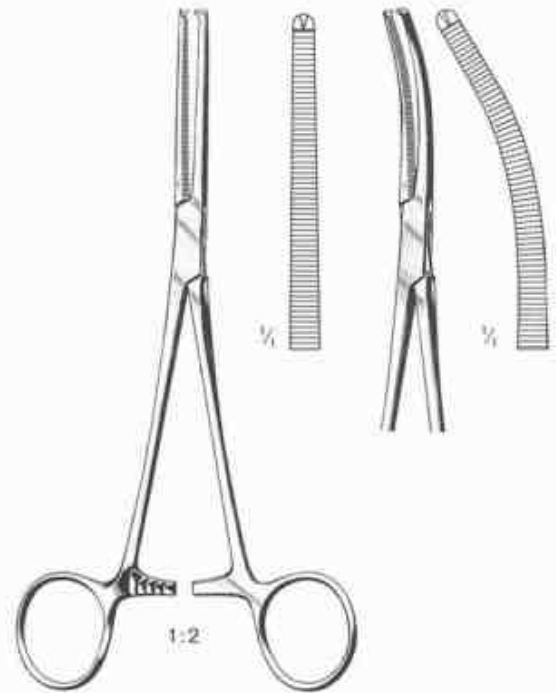
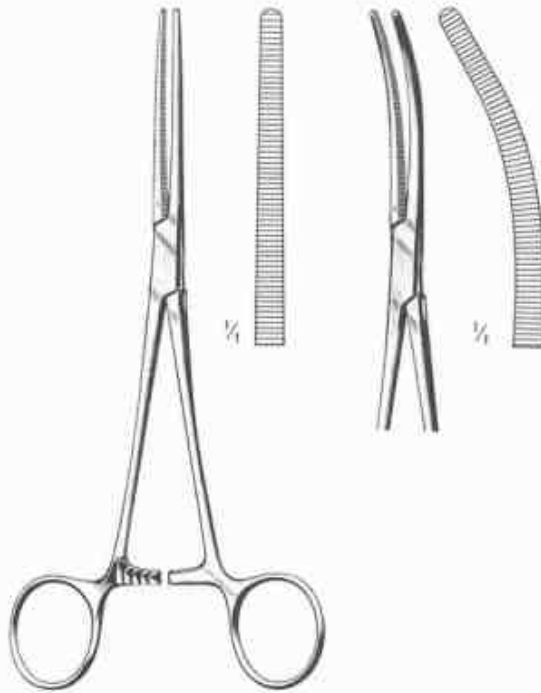

cm	ROCHESTER-PEAN	
13	12.310.13	12.311.13
14	12.310.14	12.311.14
16	12.310.16	12.311.16
18	12.310.18	12.311.18
20	12.310.20	12.311.20
22	12.310.22	12.311.22
24	12.310.24	12.311.24
26	12.310.26	12.311.26
30	12.310.30	12.311.30

cm	ROCHESTER-OCHSNER	
13	12.320.13	12.321.13
14	12.320.14	12.321.14
16	12.320.16	12.321.16
18	12.320.18	12.321.18
20	12.320.20	12.321.20
22	12.320.22	12.321.22
24	12.320.24	12.321.24
26	12.320.26	12.321.26
30	12.320.30	12.321.30

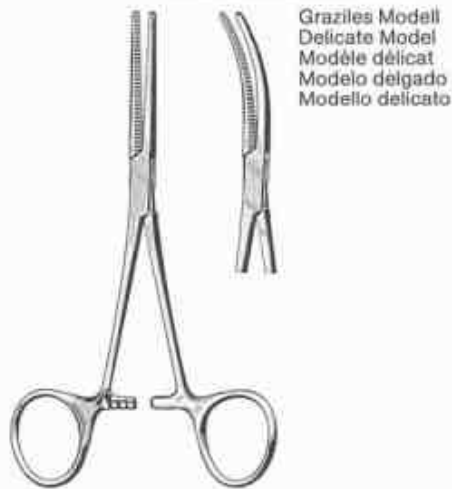

Graziles Modell
 Delicate Model
 Modèle délicat
 Modelo delgado
 Modello delicato

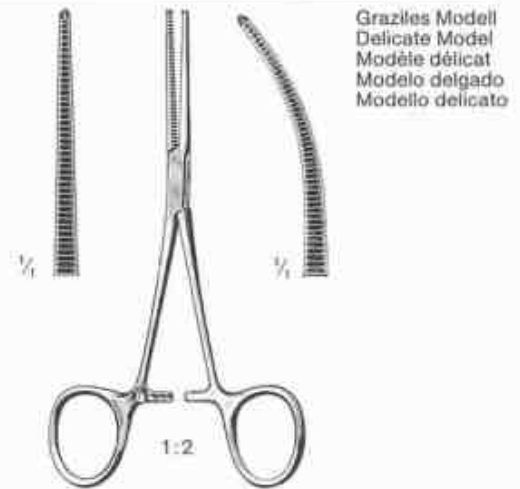

Graziles Modell
 Delicate Model
 Modèle délicat
 Modelo delgado
 Modello delicato

cm	PEAN	
12.312.14	14 cm	12.313.14
12.312.16	16 cm	12.313.16

cm	KOCHER	
12.322.14	14 cm	12.323.14
12.322.16	16 cm	12.323.16

Arterienklemmen
 Hemostatic Forceps
 Pincès hémostatiques
 Pinzas hemostáticas
 Pinze emostatische

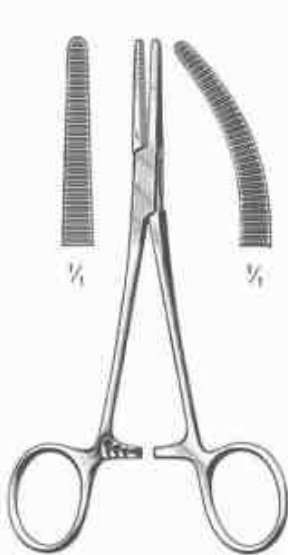

SPENCER-WELLS		
12.330.13	13 cm	12.331.13
12.330.15	15 cm	12.331.15
12.330.18	18 cm	12.331.18
12.330.20	20 cm	12.331.20

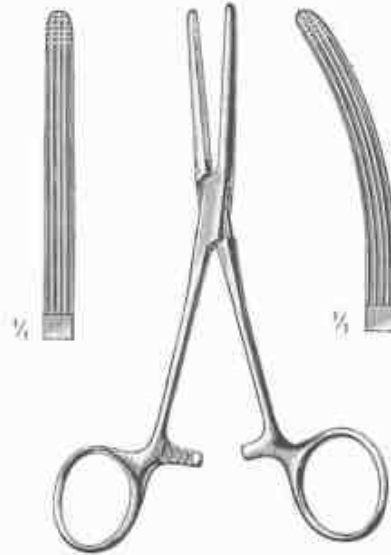

ROCHESTER-CARMALT		
12.340.16	16 cm	12.341.16
12.340.20	20 cm	12.341.20

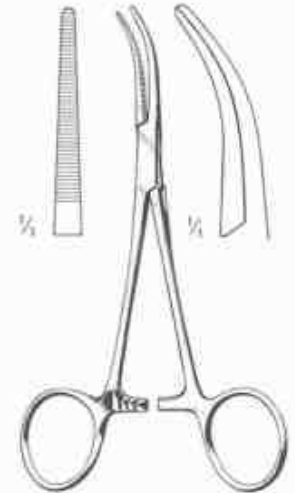

DANDY	
12.345.14	14 cm

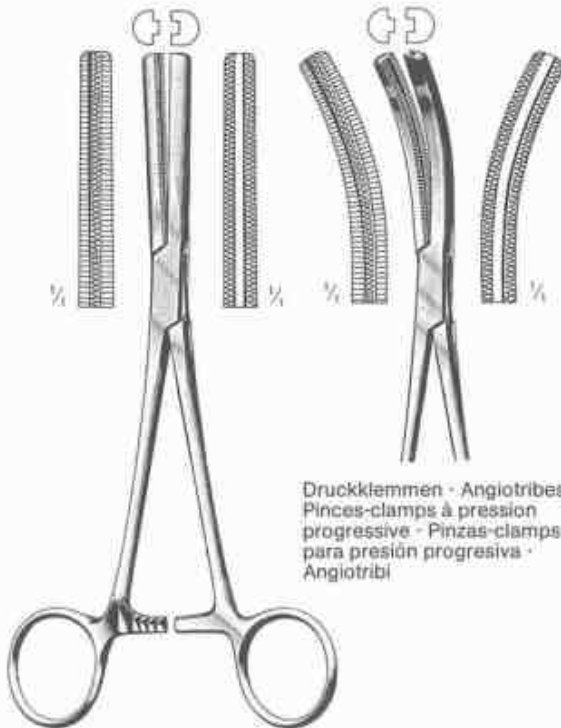

Druckklemmen · Angiotribes
 Pincès-clamps à pression
 progressive · Pinzas-clamps
 para presión progresiva ·
 Angiotribi

FERGUSSON		
12.350.16	16 cm	12.351.16
12.350.20	20 cm	12.351.20

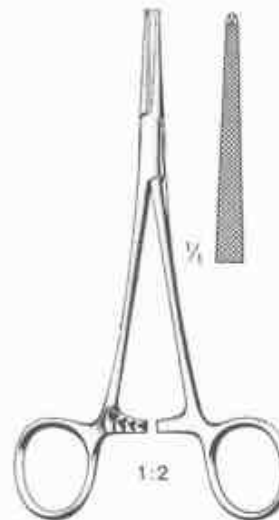

LOVELACE	
12.358.15	15,5 cm



cm	PENNINGTON	
15,5	12.358.15	
20,0	12.358.20	

Arterienklemmen
 Hemostatic Forceps
 Pincès hémostatiques
 Pinzas hemostáticas
 Pinze emostatiche

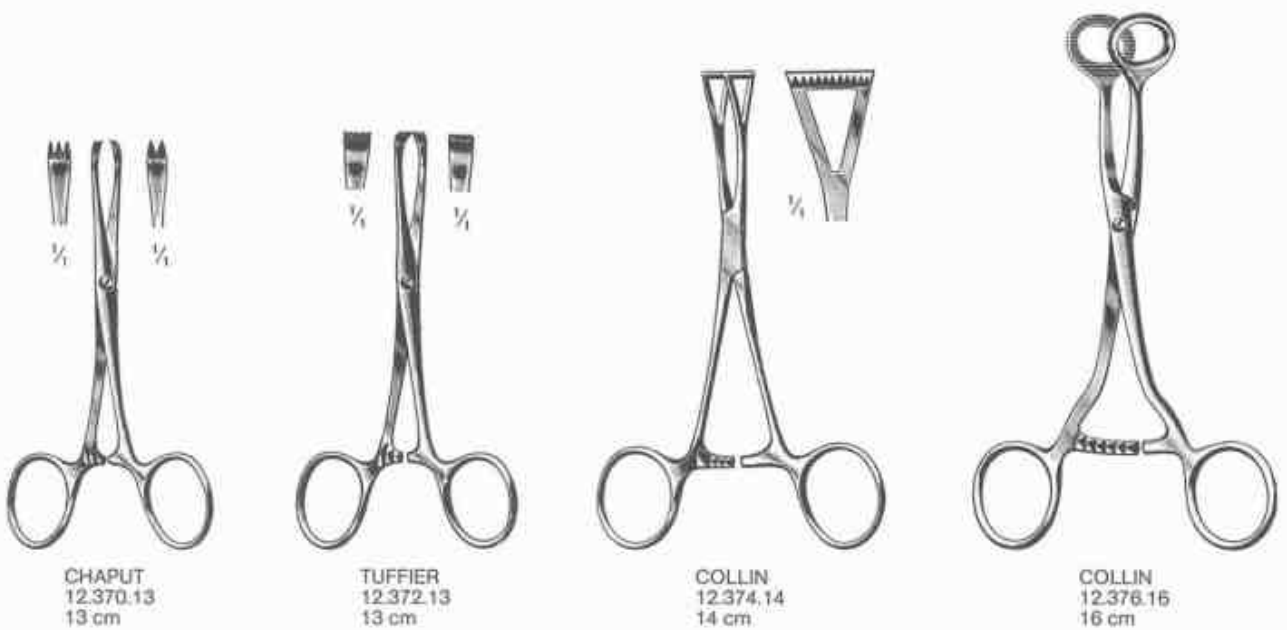
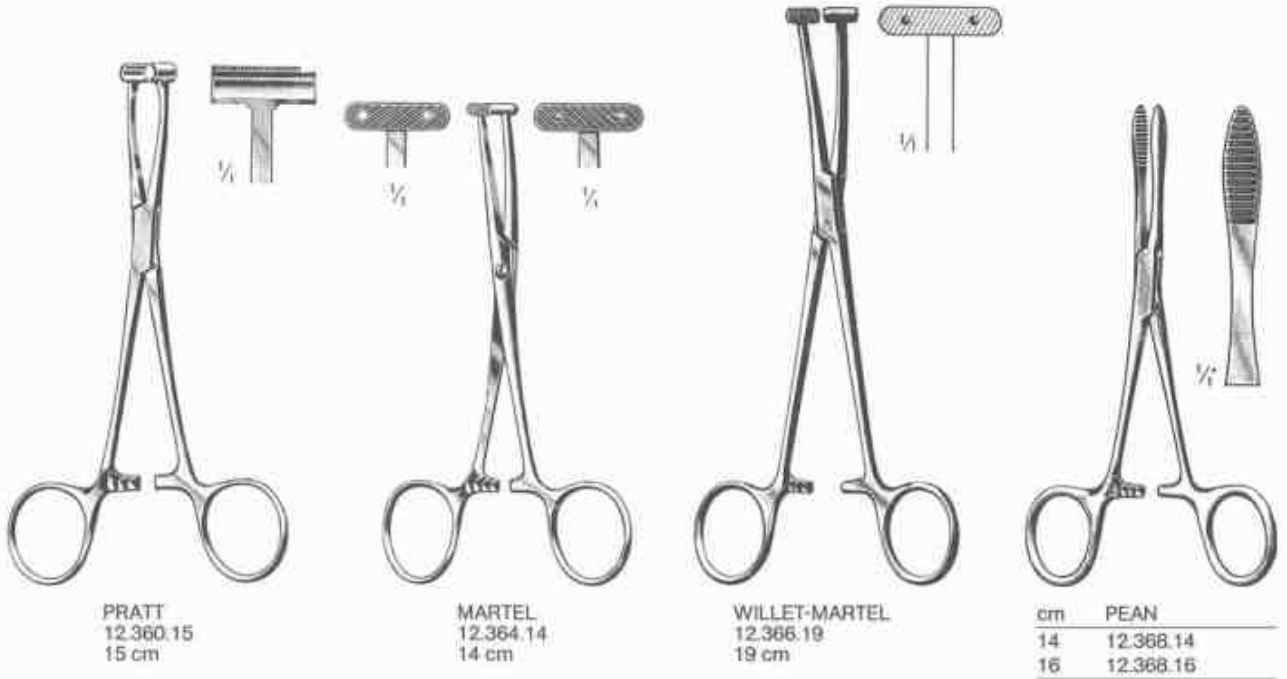

Arterienklemmen
 Hemostatic Forceps
 Pinces hémostatiques
 Pinzas hemostáticas
 Pinze emostatiche

PROFIT[®]
 Surgical Instruments

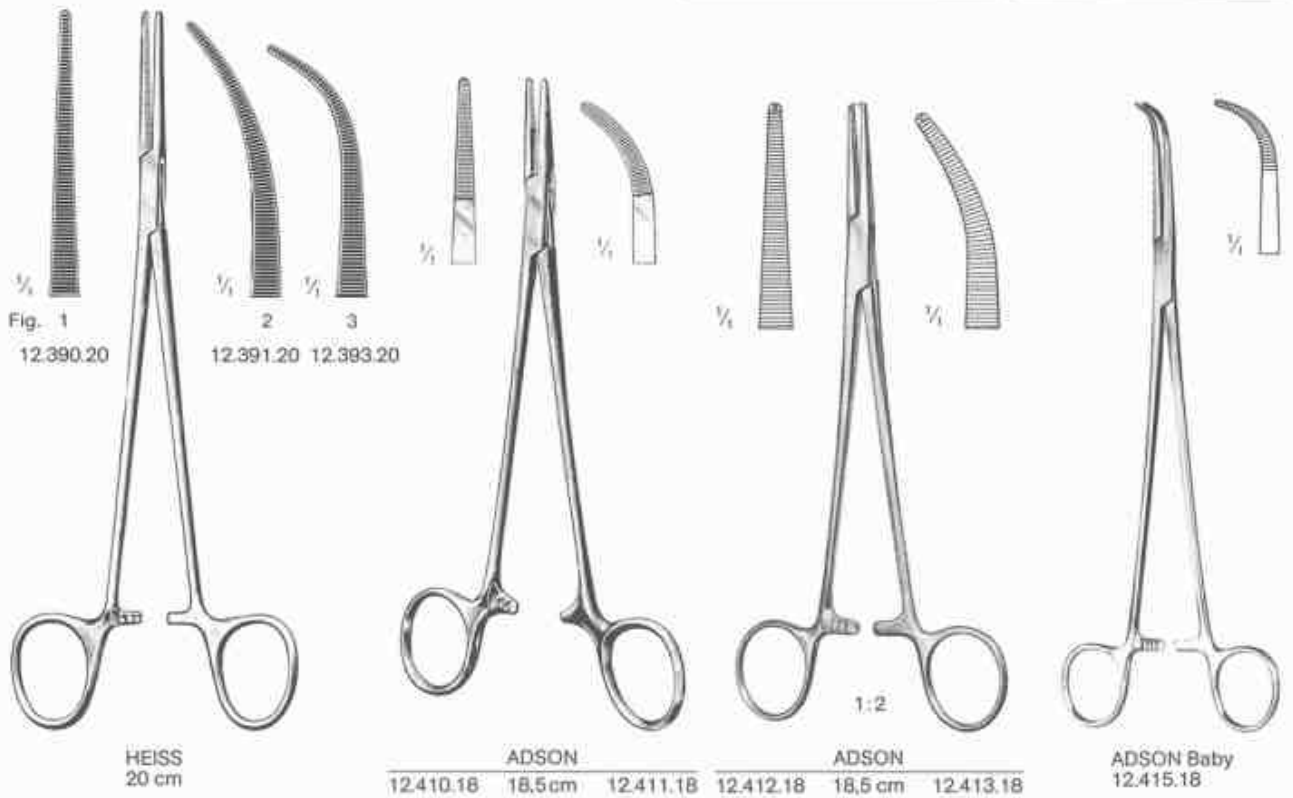
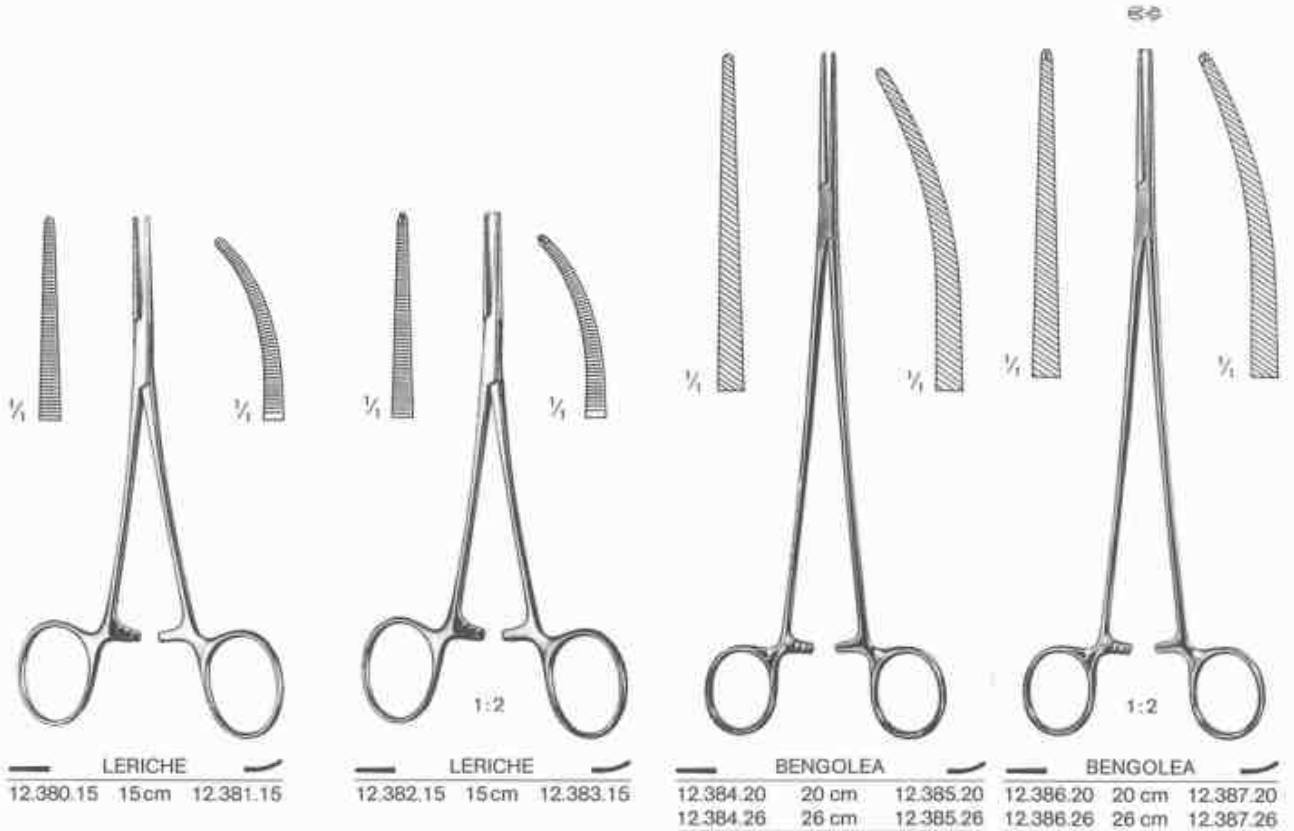

Arterienklemmen
 Hemostatic Forceps
 Pinces hémostatiques
 Pinzas hemostáticas
 Pinze emostatiche



Präparier- und Ligaturklemmen
 Dissecting and Ligature Forceps
 Pinces à dissection et à ligatures
 Pinzas para disección y ligaduras
 Pinze per dissezione e per legature (Passafili)

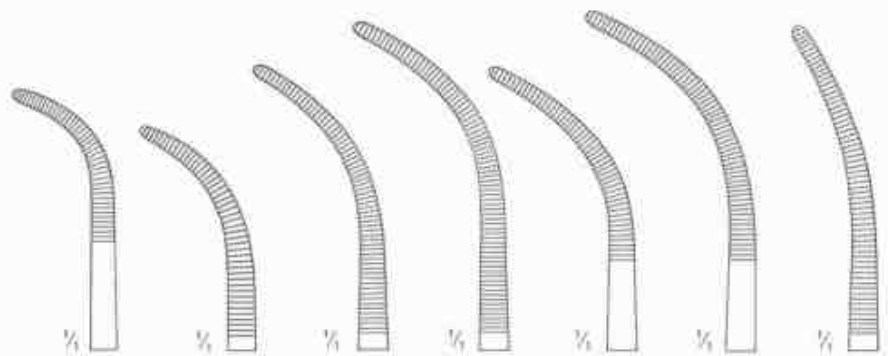

cm	Fig. 1	Fig. 2	Fig. 3	Fig. 4	Fig. 5	Fig. 6	Fig. 7
21	12.421.01	12.421.02	12.421.03	12.421.04	12.421.05	12.421.06	12.421.07
27	12.427.01	12.427.02	12.427.03	12.427.04	12.427.05	12.427.06	12.427.07

OVERHOLT-GEISSENDOERFER
 12.421.01 - 12.427.07

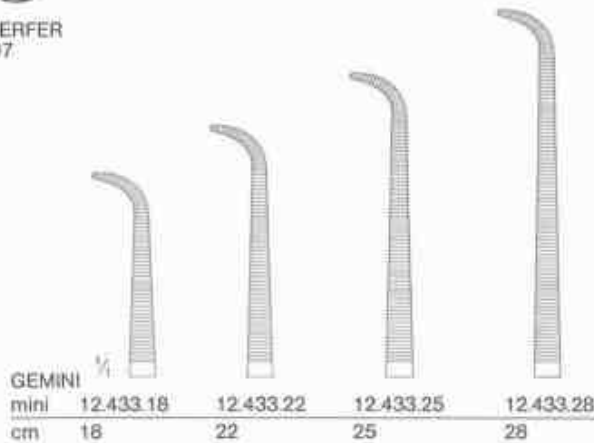

GEMINI mini	12.433.18	12.433.22	12.433.25	12.433.28
cm	18	22	25	28

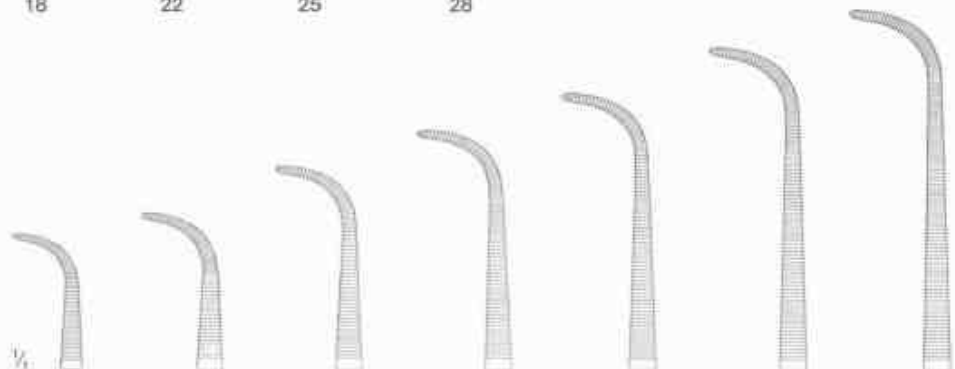

GEMINI	GEMINI 12.431.13	12.431.16	12.431.18	12.431.20	12.431.23	12.431.25	12.431.28
GEMINI mini	13 cm	16 cm	18 cm	20 cm	23 cm	25 cm	28 cm

Arterienklemmen
 Hemostatic Forceps
 Pinces hémostatiques
 Pinzas hemostáticas
 Pinze emostatiche

PROFIT[®]
 Surgical Instruments

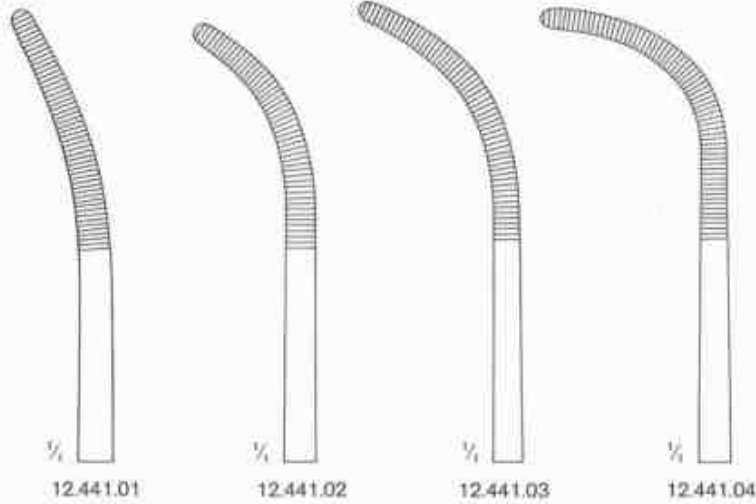

RUMEL
 12.441.01 - 12.441.04
 23 cm



TOENNIS
 12.442.21 - 12.445.26
 21 cm 26 cm

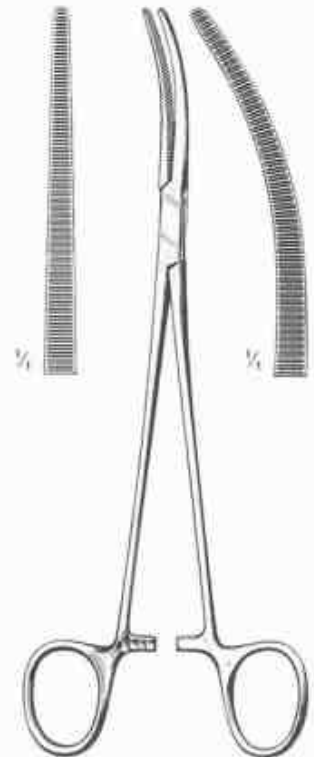

ROBERTS
 12.446.22 22 cm 12.449.22

Arterienklemmen
 Hemostatic Forceps
 Pincès hémostatiques
 Pinzas hemostáticas
 Pinze emostatiche



Bronchusklemmen
 Bronchus Forceps
 Pincès-Clamps à Bronches
 Pinzas clamps bronquiales
 Pinze per bronchi

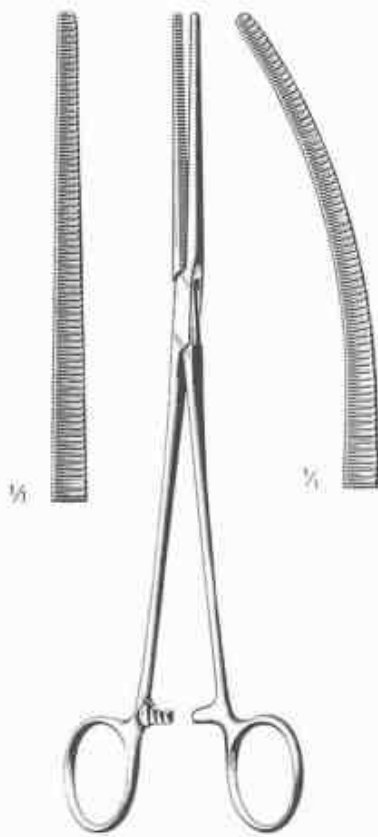

SAROT
 12.450.24 24 cm 12.451.24



CRAFOORD
 12.453.24
 24 cm

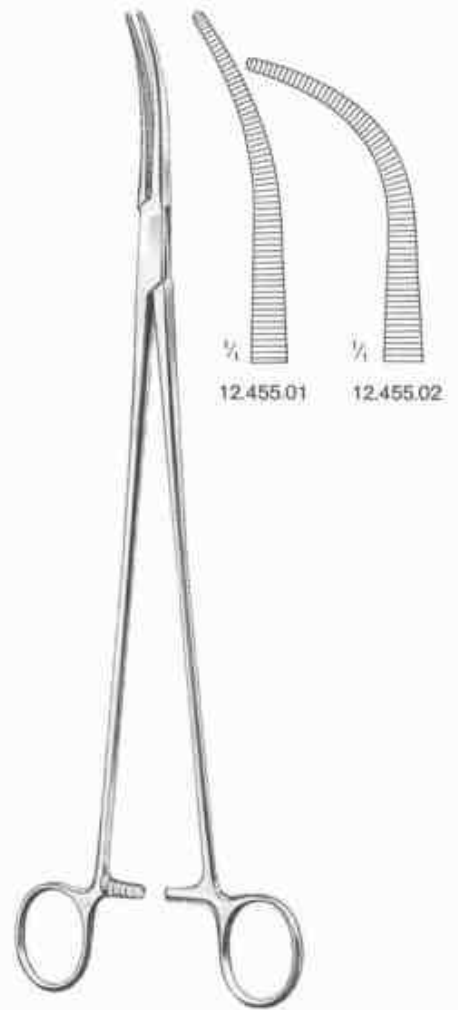

ZENKER
 12.455.01 - 12.455.02
 29,5 cm

Arterienklemmen
 Hemostatic Forceps
 Pincès hémostatiques
 Pinzas hemostáticas
 Pinze emostatiche

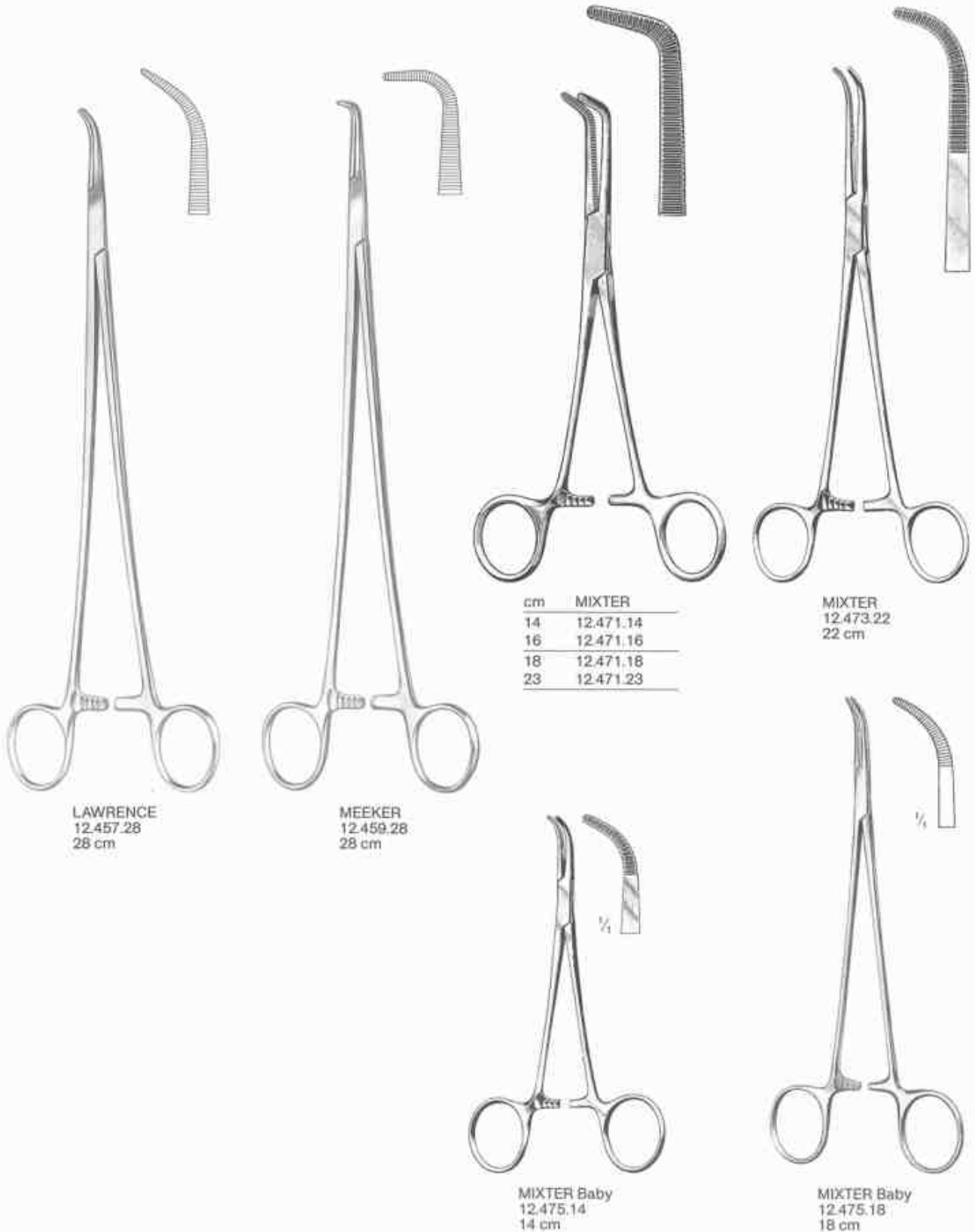

Arterienklemmen
 Hemostatic Forceps
 Pinces hémostatiques
 Pinzas hemostáticas
 Pinze emostatiche

Arterien, Gallenkanal, Nierenstiel
 Hemostatic, Gall Duct, and Kidney Pedicle
 Hémostatiques, pédicule rénal et voies biliaires
 Hemostáticas, pedículo renal y vías biliares
 Emostatiche, pedunculo renale e vie biliari

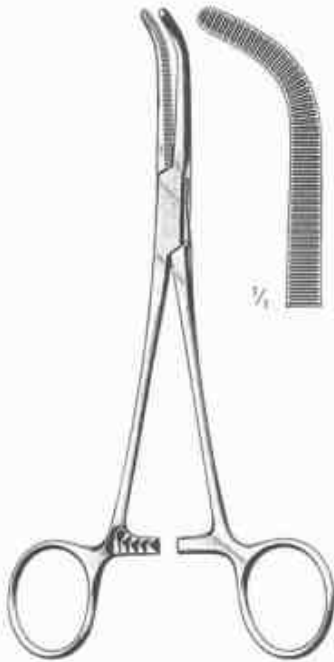

cm	MIXTER-O'SHAUGNESSY
15,5	12.477.15
19,0	12.477.19



MIXTER
 12.479.22 - 12.479.28



12.479.22 22 cm
 12.479.25 25 cm
 12.479.28 28 cm

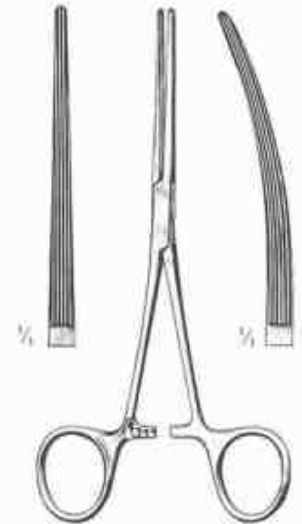

BAINBRIDGE
 12.480.15 15,0 cm 12.481.15
 12.480.18 18,5 cm 12.481.18



LAHEY
 12.491.19
 19 cm



LAHEY
 12.483.23
 23 cm



LOWER
 12.495.18
 18 cm



JOHNS-HOPKINS
 12.497.20
 20 cm

Arterienklemmen
 Hemostatic Forceps
 Pinces hémostatiques
 Pinzas hemostáticas
 Pinze emostatiche

Gallenkanal - Gall Duct -
 Voies biliaires - Vias
 biliars - Vie biliari

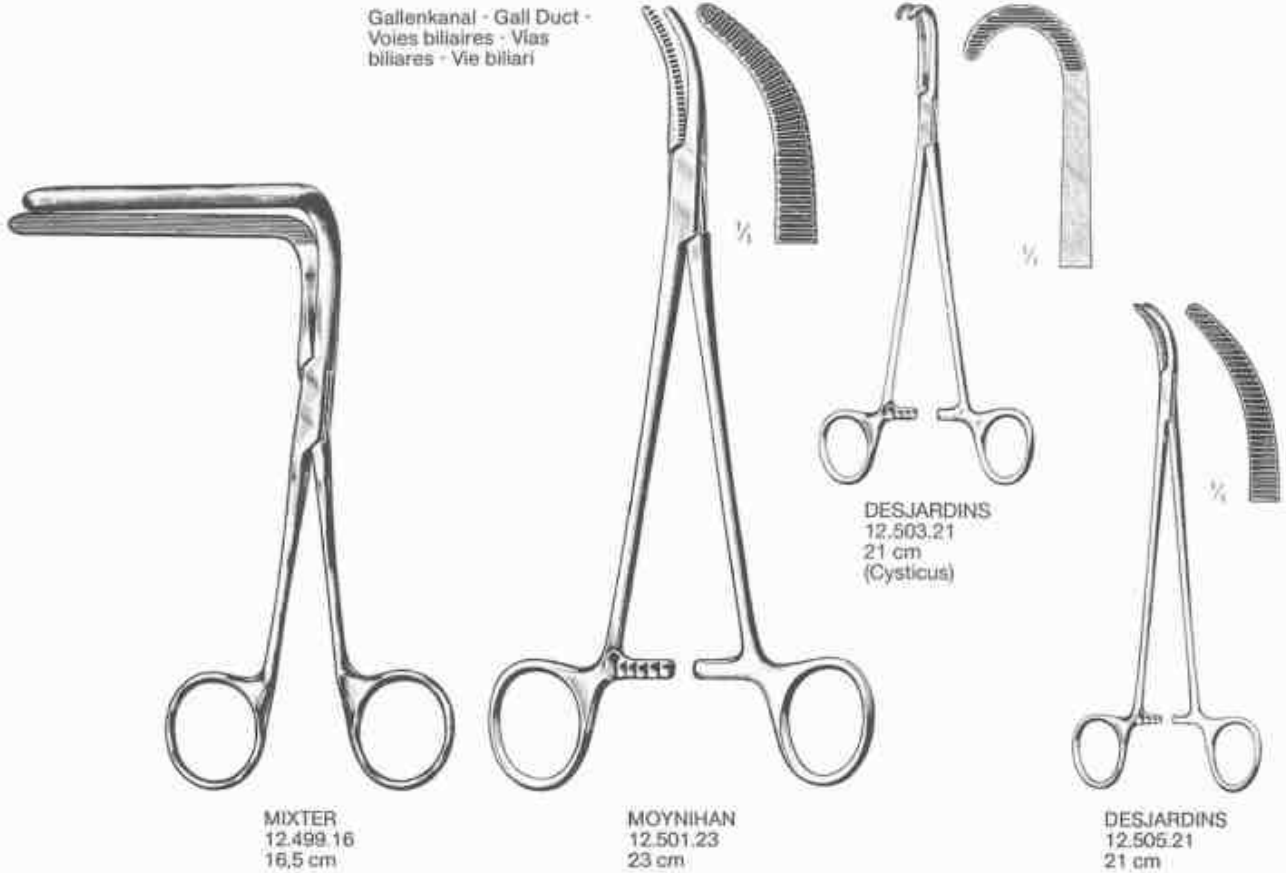

MIXTER
 12.499.16
 16,5 cm

MOYNIHAN
 12.501.23
 23 cm

DESJARDINS
 12.505.21
 21 cm



GRAY

Cholecystectomie

12.507.22
 22 cm

12.507.23
 23 cm

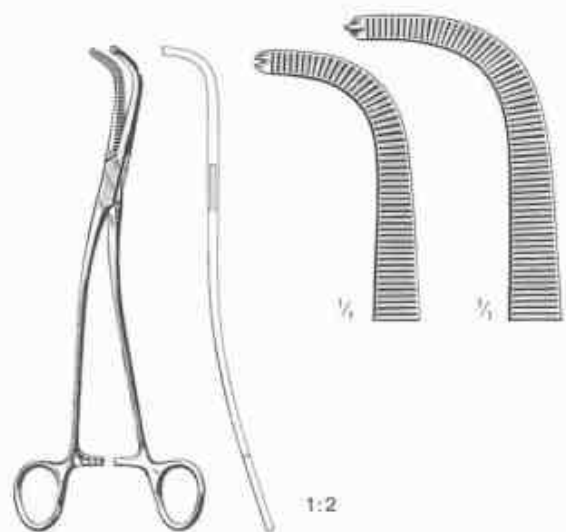

GRAY

1:2

12.509.22
 22 cm

12.509.23
 23 cm

Aterienklemmen
 Hemostatic Forceps
 Pinces hémostatiques
 Pinzas hemostáticas
 Pinze emostatiche



STILLE
 12.513.23
 23 cm

Nierenstiel, Gallenkanal
 Kidney Pedicle, Gall Duct
 Pédicule rénal, conduit biliaire
 Pediculo renal, vías biliares
 Pedunculo renale, vie biliari



MAYO-GUYON
 12.515.23
 23 cm

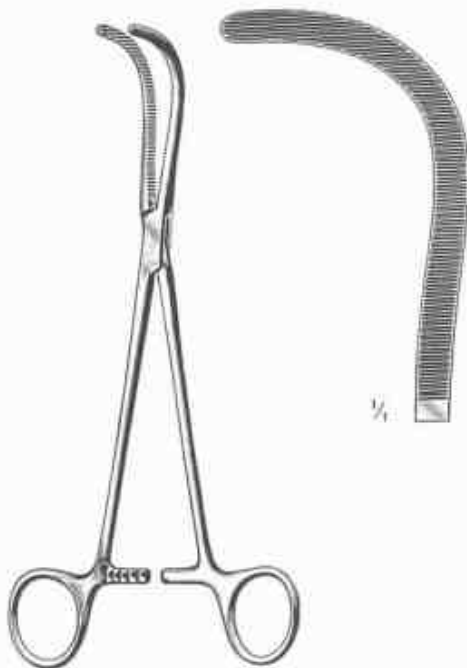

GUYON
 12.517.23
 23 cm

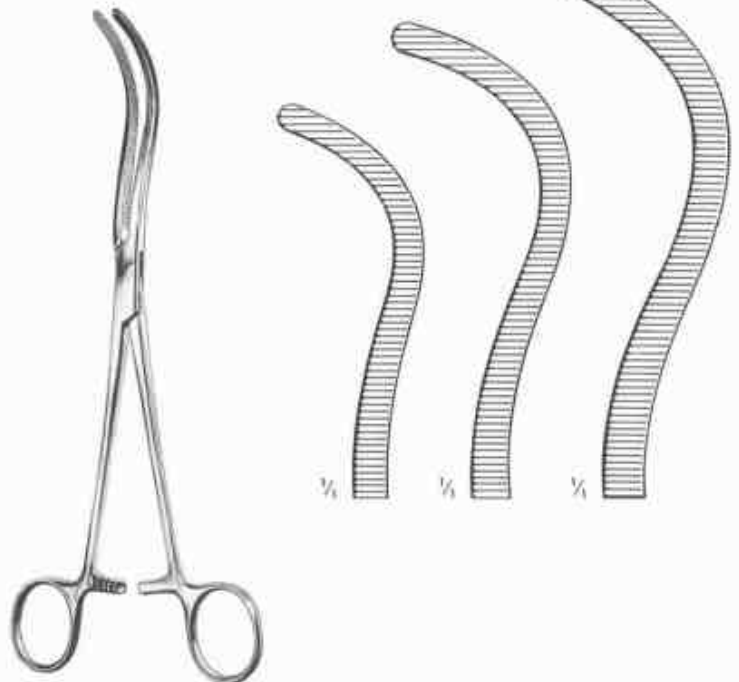

GUYON

12.519.20
 20 cm

12.519.22
 22 cm

12.519.24
 24 cm

Arterienklemmen
 Hemostatic Forceps
 Pinces hémostatiques
 Pinzas hemostáticas
 Pinze emostatiche

PROFIT[®]
 Surgical Instruments

Nierenstiel
 Kidney Pedicle
 Pédicule rénal
 Pediculo renal
 Pedunculo renale

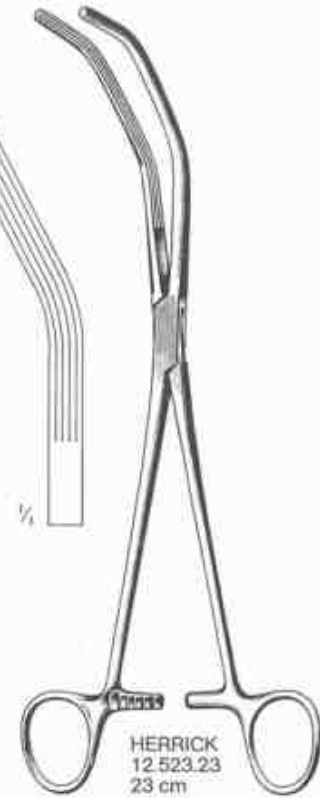

Peritoneum-Klemmen
 Peritoneum Forceps
 Pinces à péritoine
 Pinzas para peritoneo
 Pinze peritoneali



MIKULICZ
 12.551.20
 20 cm

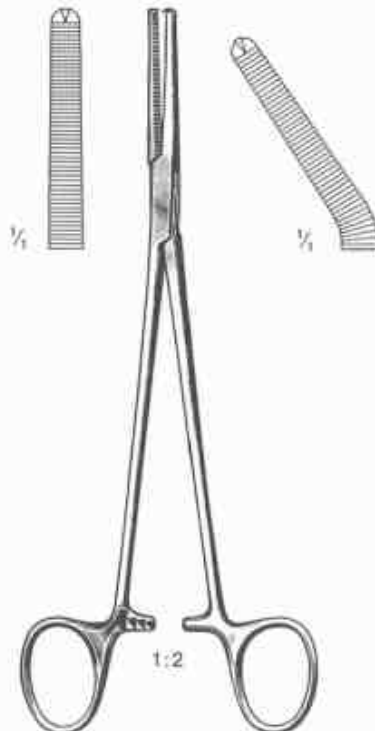

PHANELUF
 12.554.21 21 cm 12.555.21

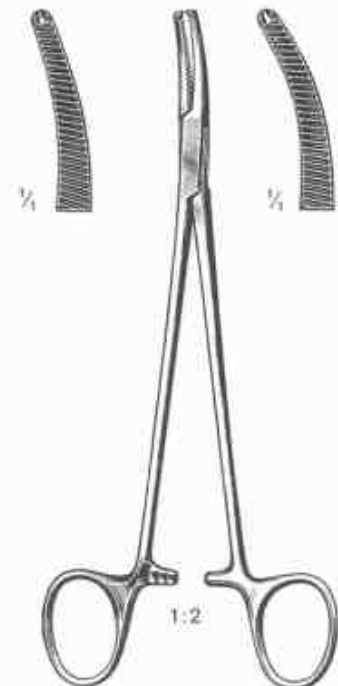

FAURE
 12.561.20 20 cm 12.563.20

Hysterektomie-Klemmen
 Hysterectomy Forceps
 Pincès à hysterectomie
 Pinzas para hysterectomia
 Pinze per isterectomia



WERTHEIM
 12.571.25
 25 cm



WERTHEIM
 12.573.22 22 cm 12.575.23
 23 cm



WERTHEIM-CULLEN
 12.579.21
 21,5 cm



HEANEY
 21,5 cm 12.591.20 12.593.20

Schlauchklemmen
 Tubing Clamps
 Pincas serre-tubes
 Pinzas cierra-tubos
 Pinze serretubi

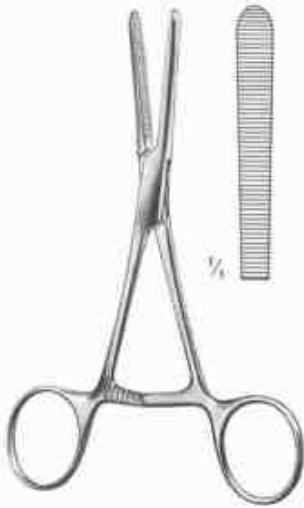

WEISS
 12.702.14
 14,5 cm

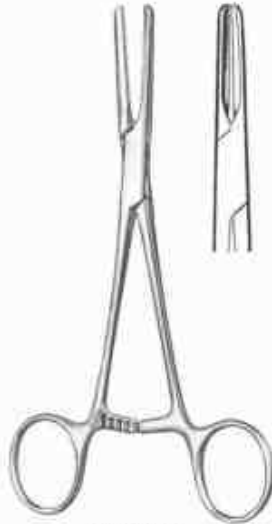

MURPHY
 12.710.15 - 12.710.20



12.710.15
 15 cm



12.710.18
 18 cm



12.710.20
 20 cm

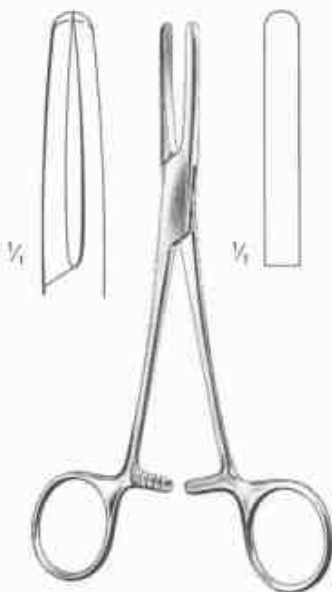

PRESBYTERIAN HOSPITAL
 12.704.16 16 cm
 12.704.18 18 cm



12.712.15 - 12.712.20



12.712.15
 15 cm



12.712.18
 18 cm



12.712.20
 20 cm

Atraumatische Gefäßklemmen
 Atraumatic Hemostatic Forceps
 Pinces hémostatiques atraumatiques
 Pinzas hemostáticas atraumáticas
 Pinze emostatiche atraumatiche

PROFIT[®]
 Surgical Instruments



cm — HALSTEAD-MOSQUITO —
 12,0 13.080.12 13.081.12
 15,0 13.080.15 13.081.15

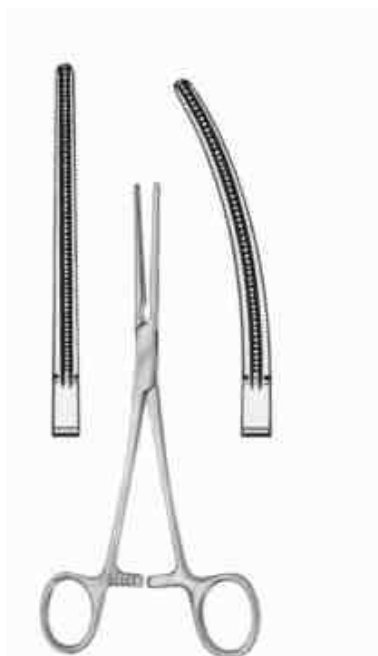

cm — PEAN —
 14,0 13.082.14 13.083.14
 16,0 13.082.16 13.083.16
 18,0 13.082.18 13.083.18
 20,0 13.082.20 13.083.20



cm — RANKIN —
 16,0 13.084.16 13.085.16



cm — DE BAKEY —
 12,0 13.102.12 13.103.12



DE BAKEY
 13.111.12
 12,0 cm



DE BAKEY
 13.113.12
 12,0 cm



DE BAKEY
 13.121.12
 12,0 cm

Atraumatische Gefäßklemmen
 Atraumatic Hemostatic Forceps
 Pinces hémostatiques atraumatiques
 Pinzas hemostáticas atraumáticas
 Pinze emostatiche atraumatiche

PROFIT[®]
 Surgical Instruments

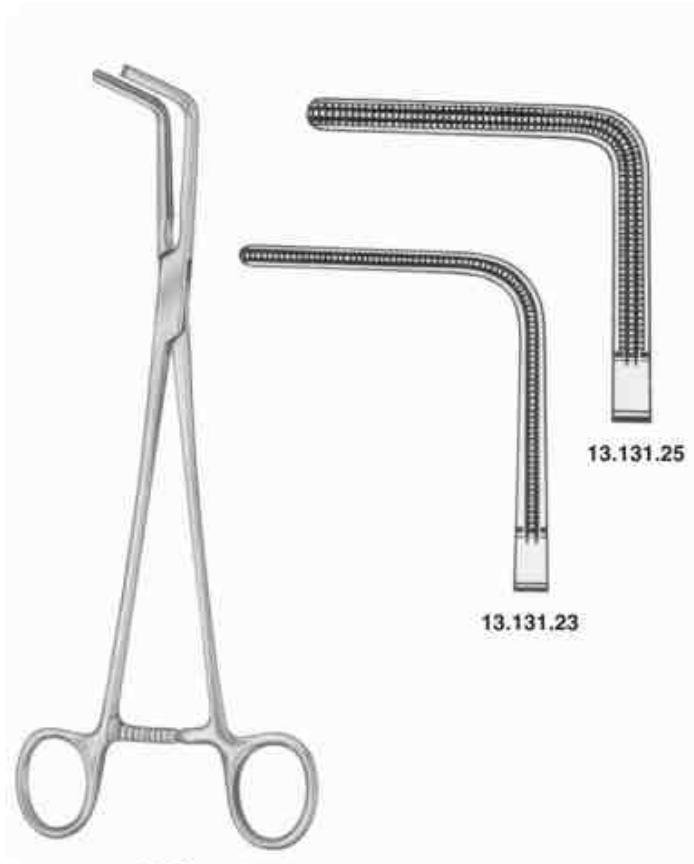

13.131.25

13.131.23

cm	LEES
23,0	13.131.23
25,0	13.131.25

Bronchusklemmen
 Bronchus Forceps
 Pinces-Clamps à Bronches
 Pinzas clamps bronquiales
 Pinze per bronchi



LEES
 13.133.25
 25,0 cm

Atraumatische Gefäßklemmen
 Atraumatic Hemostatic Forceps
 Pincès hémostatiques atraumatiques
 Pinzas hemostáticas atraumáticas
 Pinze emostatiche atraumatiche

PROFIT[®]
 Surgical Instruments

Coarctationsklemmen
 Coarction Clamps
 Pincès à coarctation
 Pinzas para coarctación
 Pinze per coarctazione

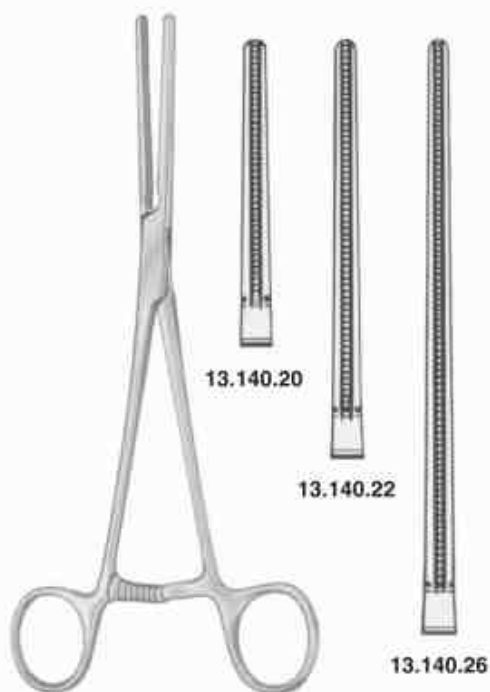

cm	POTTS
20,0	13.140.20
22,5	13.140.22
26,0	13.140.26

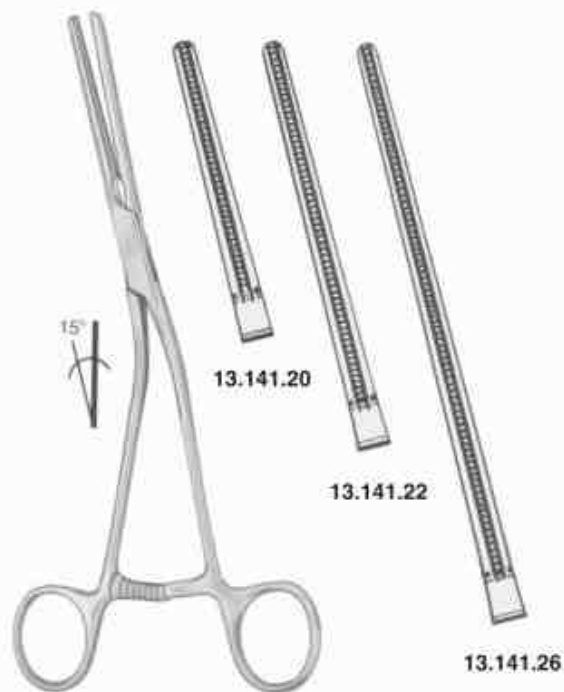

cm	GLOVER
20,0	13.141.20
22,5	13.141.22
26,0	13.141.26

Atraumatische Gefäßklemmen
 Atraumatic Hemostatic Forceps
 Pinces hémostatiques atraumatiques
 Pinzas hemostáticas atraumáticas
 Pinze emostatiche atraumatiche



Anastomosenklemmen
 Anastomosis Clamps
 Pinces à anastomose
 Pinzas para anastomosis
 Pinze per anastomosi

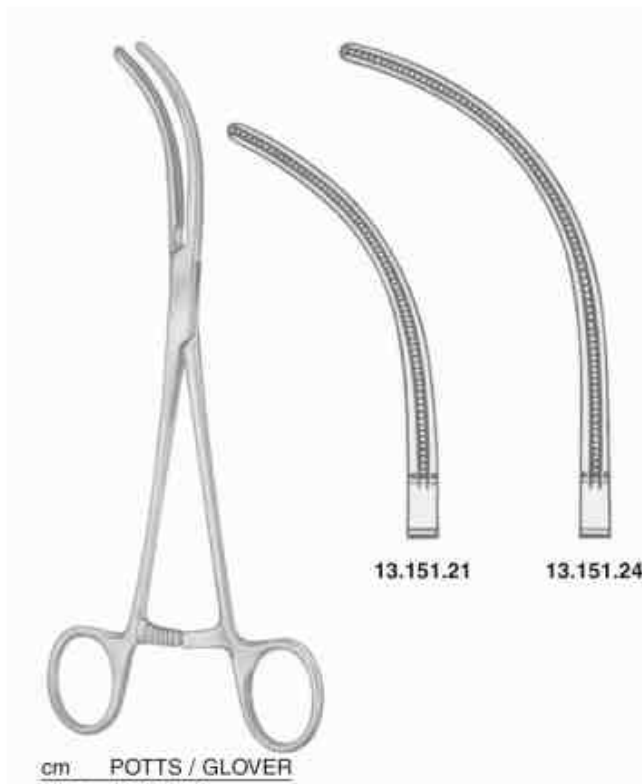

cm	POTTS / GLOVER
21,0	13.151.21
24,0	13.151.24

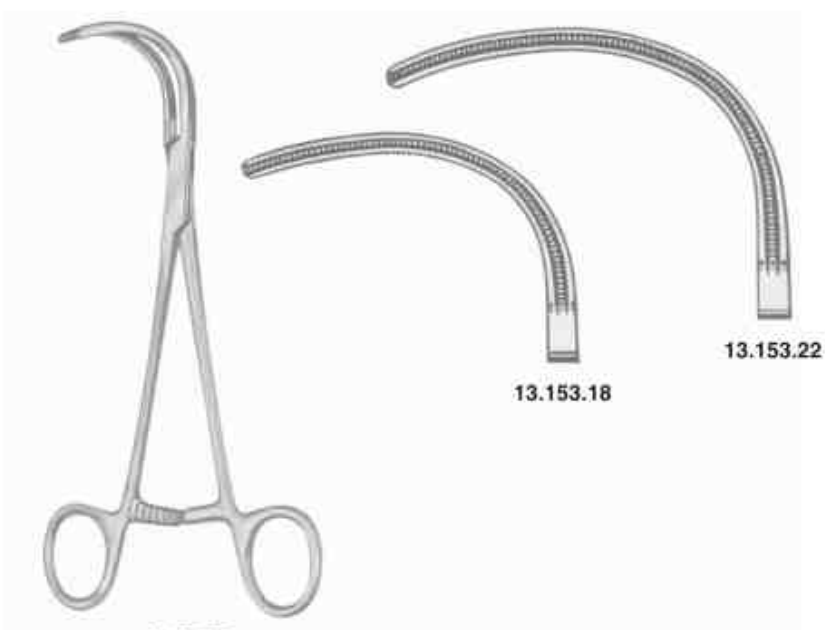

cm	GLOVER
18,0	13.153.18
22,0	13.153.22

Atraumatische Gefäßklemmen
 Atraumatic Hemostatic Forceps
 Pincès hémostatiques atraumatiques
 Pinzas hemostáticas atraumáticas
 Pinze ernostatiche atraumatiche

PROFIT[®]
 Surgical Instruments

Vascularklemme löffelförmig
 Vascular Clamps Spoon Shaped
 Pince vasculaire forme cuiller
 Pinza vascular forma cuchara
 Pinza vascolare forma cucchiaio

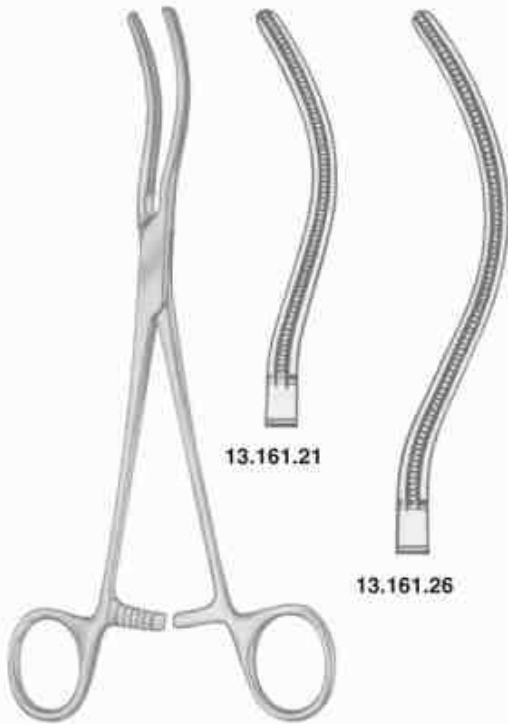

13.161.21

13.161.26

cm	GLOVER
21,0	13.161.21
26,0	13.161.26

Peripher-Vascularklemmen
 Peripheral Vascular Forceps
 Pincès vasculaires périph.
 Pinzas vasculares perif.
 Pinze vascolari perif.

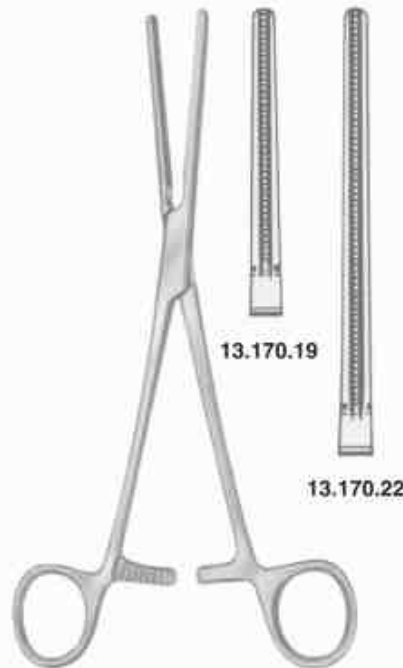

13.170.19

13.170.22

cm	DE BAKEY
18,0	13.170.19
22,0	13.170.22

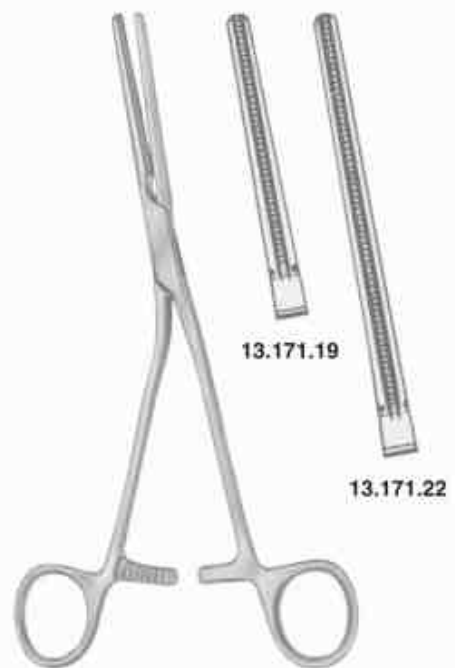

13.171.19

13.171.22

cm	DE BAKEY
18,0	13.171.19
22,0	13.171.22

Atraumatische Gefäßklemmen
 Atraumatic Hemostatic Forceps
 Pincès hémostatiques atraumatiques
 Pinzas hemostáticas atraumáticas
 Pinze emostatiche atraumatiche



Atraumatische Mehrzweckklemmen
 Atraumatic Multi-Purpose Clamps
 Pincès-clamps polyvalentes
 Pinzas clamps para usos varios
 Pinze atraumatiche per diversi usi



DARDIK

cm	0°	15°	30°	45°	90°
14,0	--	--	--	--	13.172.90
15,0	13.172.00	13.172.15	13.172.30	13.172.45	--

cm	0°	15°	30°	45°	90°
16,0	--	--	--	--	13.174.90
17,0	13.174.00	13.174.15	13.174.30	13.174.45	--

Atraumatische Gefäßklemmen
 Atraumatic Hemostatic Forceps
 Pincès hémostatiques atraumatiques
 Pinzas hemostáticas atraumáticas
 Pinze emostatiche atraumatiche

PROFIT[®]
 Surgical Instruments

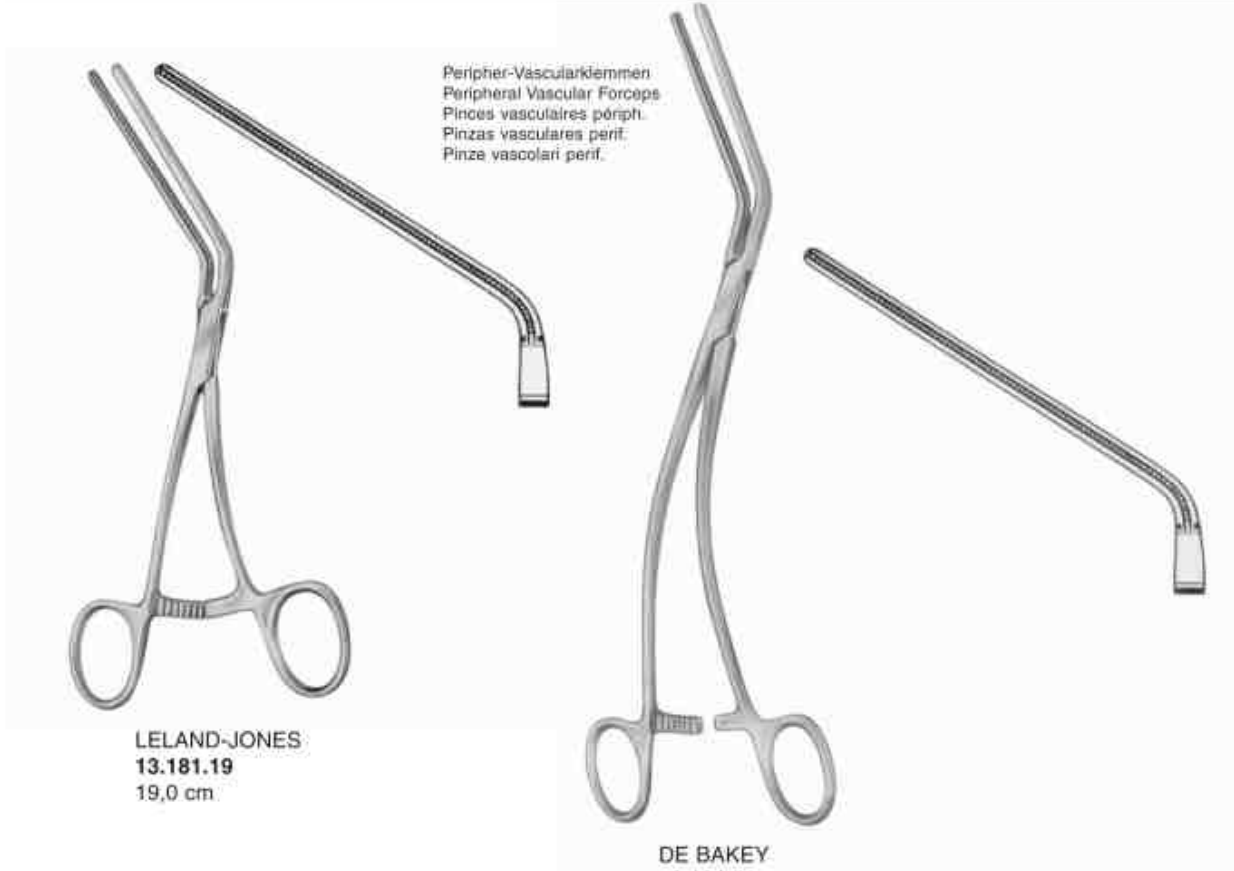

LELAND-JONES
 13.181.19
 19,0 cm

DE BAKEY
 13.181.26
 26,0 cm

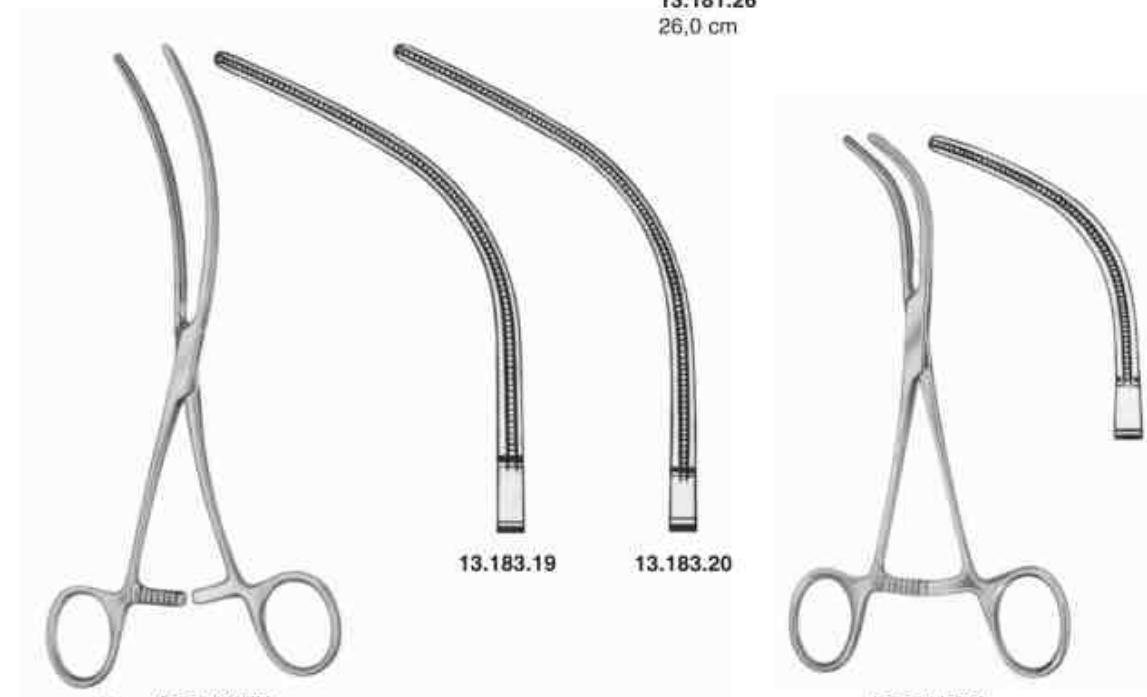

cm	DE BAKEY
19,0	13.183.19
20,0	13.183.20

DE BAKEY
 13.191.16
 16,0 cm

Atraumatische Gefäßklemmen
 Atraumatic Hemostatic Forceps
 Pincès hémostatiques atraumatiques
 Pinzas hemostáticas atraumáticas
 Pinze emostatiche atraumatiche

PROFIT[®]
 Surgical Instruments

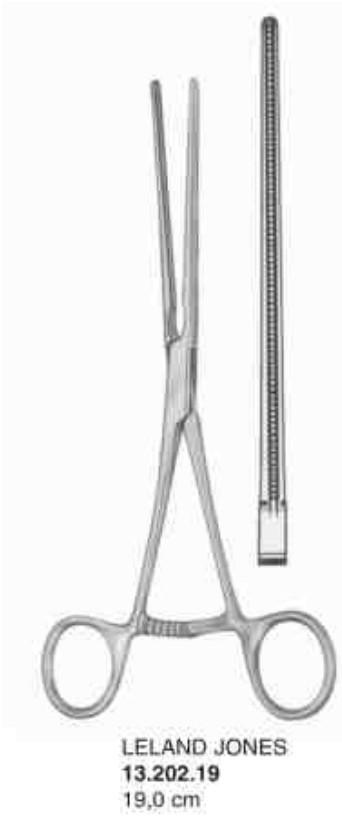
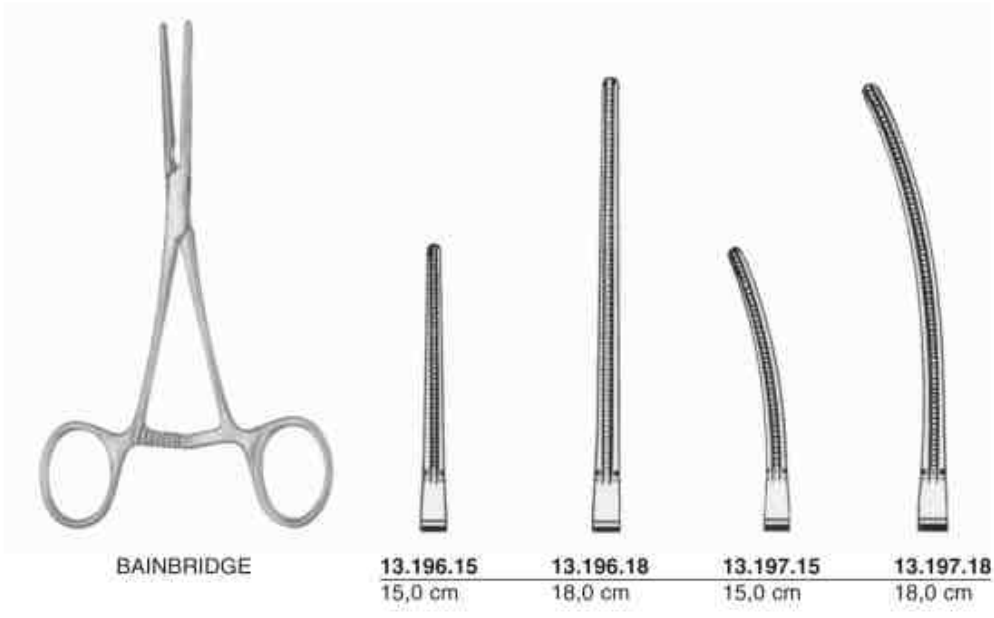

Peripher-Vascularklemmen
 Peripheral Vascular Forceps
 Pincès vasculaires périph.
 Pinzas vasculares perif.
 Pinze vascolari perif.

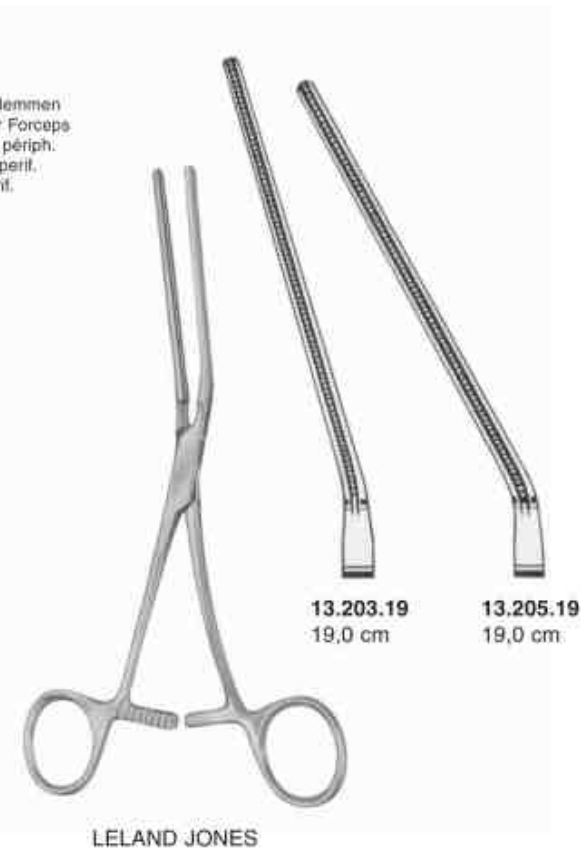

Atraumatische Gefäßklemmen
Atraumatic Hemostatic Forceps
Pincés hémostatiques atraumatiques
Pinzas hemostáticas atraumáticas
Pinze emostatiche atraumatiche

PROFIT[®]
Surgical Instruments

Aortaklemmen
Aortic Clamp
Pince-clamp à aorte
Pinza clamp para aorta
Pinza per aorta



LIDDLE
13.209.27
27,0 cm

Aorta-Anastomosenklemmen
Aorta-Anastomosis Clamps
Pincés-clamps pour anastomoses d'aorte
Pinzas clamps para anastomosis de aorta
Pinze aortiche



LAMBERT KAY
13.211.20
20,0 cm

Atraumatische Gefäßklemmen
Atraumatic Hemostatic Forceps
Pinces hémostatiques atraumatiques
Pinzas hemostáticas atraumáticas
Pinze emostatiche atraumatiche

PROFIT[®]
Surgical Instruments

Iliaca-Klemme
Iliac Clamp
Pinça-clamp à iliaque
Pinza clamp para iliaca
Pinza per iliaca



LAMBERT KAY
13.213.20
20,0 cm



DE BAKEY
13.215.20
20,0 cm

Atraumatische Gefäßklemmen
Atraumatic Hemostatic Forceps
Pinces hémostatiques atraumatiques
Pinzas hemostáticas atraumáticas
Pinze emostatiche atraumatiche

PROFIT[®]
Surgical Instruments



WEBER
13.217.26
26,0 cm



WEBER
13.219.26
26,0 cm

Atraumatische Gefäßklemmen
Atraumatic Hemostatic Forceps
Pinces hémostatiques atraumatiques
Pinzas hemostáticas atraumáticas
Pinze emostatiche atraumatiche

PROFIT[®]
Surgical Instruments

Aorta-Aneurysma-Klemmen
Aorta-Aneurysm Clamps
Pinces-clamps pour aneurysme d'aorte
Pinzas clamps para aneurisma de aorta
Pinze per aneurisma di aorta



DE BAKEY

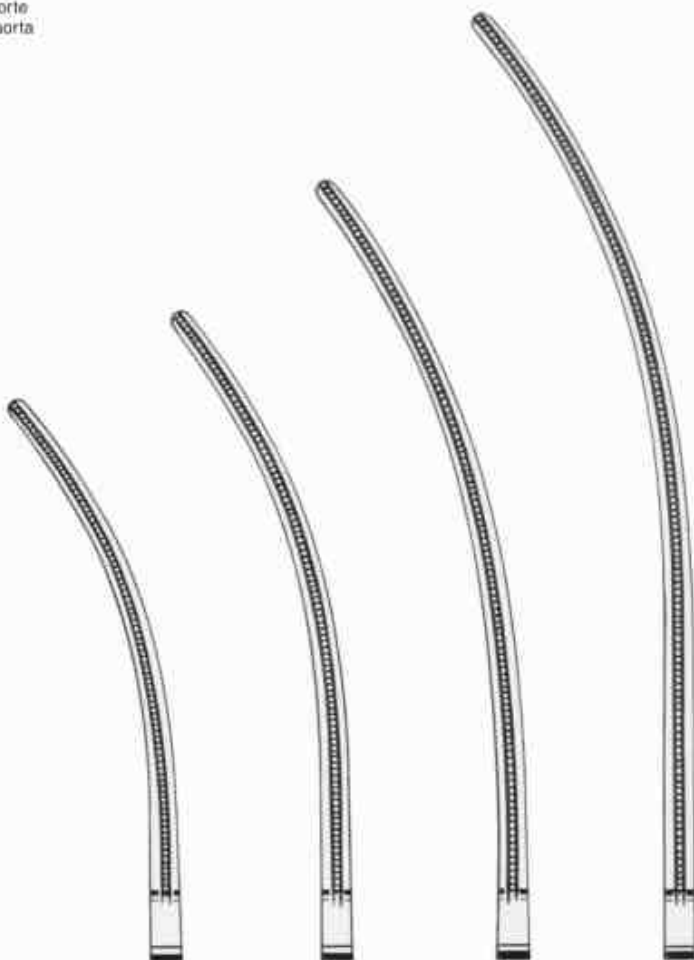

13.221.24
24,0 cm

13.221.27
27,0 cm

13.221.31
31,0 cm

13.221.35
35,0 cm

Atraumatische Gefäßklemmen
Atraumatic Hemostatic Forceps
Pincés hémostatiques atraumatiques
Pinzas hemostáticas atraumáticas
Pinze emostatiche atraumatiche

PROFIT[®]
Surgical Instruments

Aorta-Aneurysma-Klemmen
Aorta-Aneurysm Clamps
Pincés-clamps pour aneurysme d'aorte
Pinzas clamps para aneurisma de aorta
Pinze per aneurisma di aorta



Atraumatische Gefäßklemmen
Atraumatic Hemostatic Forceps
Pinces hémostatiques atraumatiques
Pinzas hemostáticas atraumáticas
Pinze emostatiche atraumatiche

PROFIT[®]
Surgical Instruments

Aorta-Aneurysma-Klemmen
Aorta-Aneurysm Clamps
Pinces-clamps pour aneurysme d'aorte
Pinzas clamps para aneurisma de aorta
Pinze per aneurisma di aorta



DE BAKEY
13.225.28
28,0 cm



DE BAKEY
13.227.28
28,0 cm

Atraumatische Gefäßklemmen
Atraumatic Hemostatic Forceps
Pincès hémostatiques atraumatiques
Pinzas hemostáticas atraumáticas
Pinze emostatiche atraumatiche

PROFIT[®]
Surgical Instruments

Atraumatische Mehrzweckklemmen
Atraumatic Multi-Purpose Clamps
Pincès-clamps polyvalents
Pinzas clamps para usos varios
Pinze atraumatiche per diversi usi



DE BAKEY MORRIS

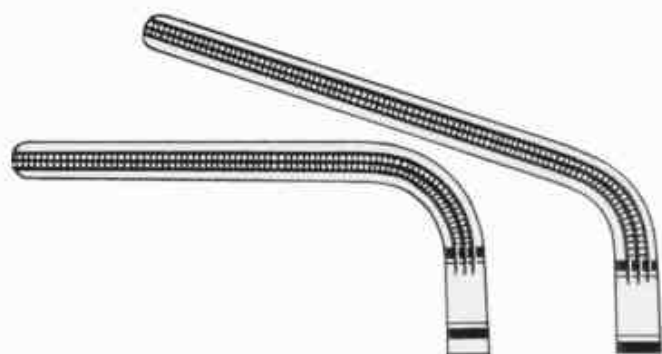

13.229.18
18,0 cm

13.229.20
20,0 cm



13.229.23
23,0 cm

13.229.25
25,0 cm

Atraumatische Gefäßklemmen
Atraumatic Hemostatic Forceps
Pinces hémostatiques atraumatiques
Pinzas hemostáticas atraumáticas
Pinze emostatiche atraumatiche

PROFIT[®]
Surgical Instruments

Atraumatische Mehrzweckklemmen
Atraumatic Multi-Purpose Clamps
Pinces-clamps polyvalentes
Pinzas clamps para usos varios
Pinze atraumatiche per diversi usi

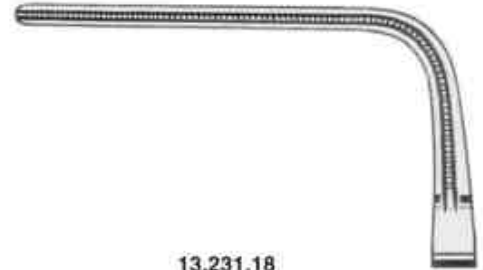

13.231.18
18,0 cm

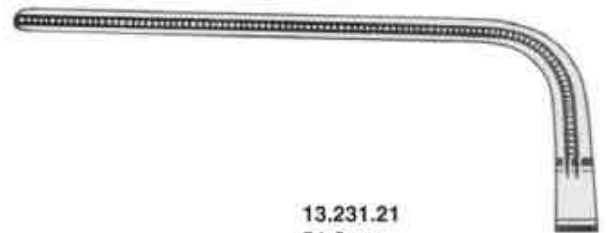

13.231.21
21,0 cm

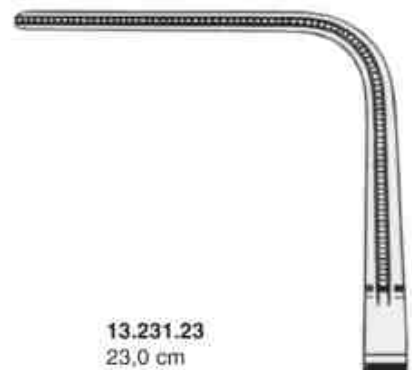

13.231.23
23,0 cm



13.231.27
27,0 cm



DE BAKEY

Atraumatische Gefäßklemmen
Atraumatic Hemostatic Forceps
Pinces hémostatiques atraumatiques
Pinzas hemostáticas atraumáticas
Pinze emostatiche atraumatiche

PROFIT[®]
Surgical Instruments

Aorta-Aneurysma-Klemmen
Aorta-Aneurysm Clamps
Pinces-clamps pour aneurysme d'aorte
Pinzas clamps para aneurisma de aorta
Pinze per aneurisma di aorta



DE BAKEY



13.241.25
25,0 cm

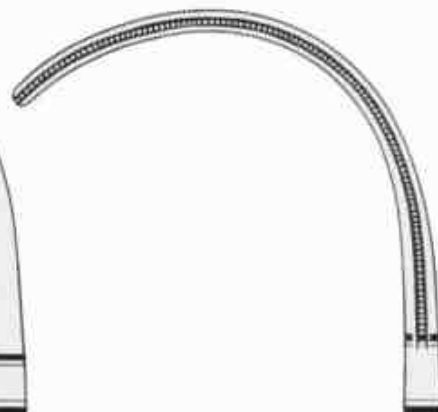

13.241.26
26,0 cm

Atraumatische Gefäßklemmen
Atraumatic Hemostatic Forceps
Pinces hémostatiques atraumatiques
Pinzas hemostáticas atraumáticas
Pinze emostatiche atraumatiche

PROFIT[®]
Surgical Instruments

Bronchus-Klemmen
Bronchus Clamps
Pinces pour les bronches
Pinzas bronquiales
Pinze per bronchi



DE BAKEY
13.247.27
27,0 cm

Atraumatische Gefäßklemmen
 Atraumatic Hemostatic Forceps
 Pinces hémostatiques atraumatiques
 Pinzas hemostáticas atraumáticas
 Pinze emostatiche atraumatiche

PROFIT[®]
 Surgical Instruments



DE BAKAY

13.251.20
 20,0 cm

13.251.24
 24,0 cm

13.251.25
 25,0 cm

13.251.30
 30,0 cm

Atraumatische Mehrzweckklemmen
 Atraumatic Multi-Purpose Clamps
 Pinces-clamps polyvalentes
 Pinzas clamps para usos varios
 Pinze atraumatiche per diversi usi



SATINSKY

13.253.20
 20,0 cm

13.253.24
 24,0 cm

13.253.25
 25,0 cm

13.253.26
 26,0 cm

13.253.27
 27,0 cm

Atraumatische Gefäßklemmen
 Atraumatic Hemostatic Forceps
 Pincès hémostatiques atraumatiques
 Pinzas hemostáticas atraumáticas
 Pinze emostatiche atraumatiche



Anlegezange für Clips
 Applying for Clips
 Applicateur pour clips
 Pinza para aplicar clips
 Applicatore per clips

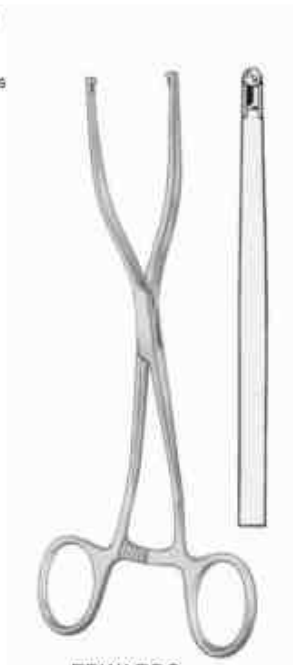

EDWARDS
 13.258.00

Clips
 Clips
 Clips
 Clips
 Clips



mm	EDWARDS
6	13.258.06
12	13.258.12

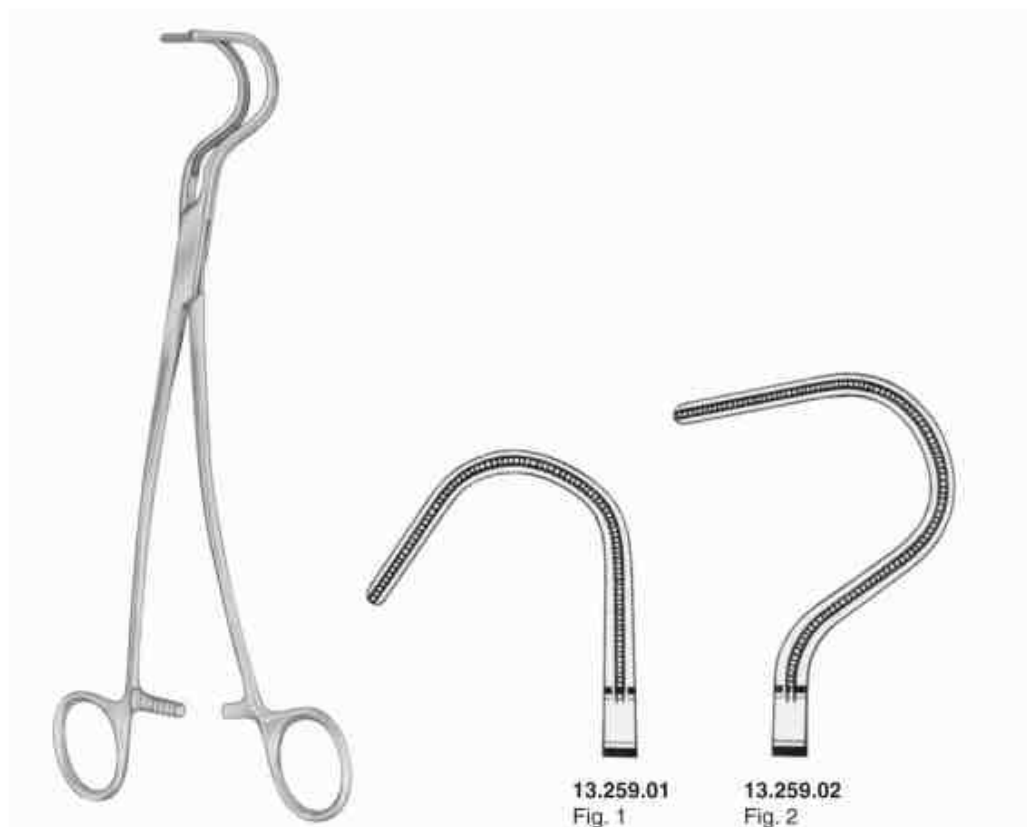

WYLIE

13.259.01
 Fig. 1
 21,0 cm

13.259.02
 Fig. 2
 22,0 cm

Atraumatische Gefäßklemmen
Atraumatic Hemostatic Forceps
Pincès hémostatiques atraumatiques
Pinzas hemostáticas atraumáticas
Pinze emostatiche atraumatiche

PROFIT[®]
Surgical Instruments

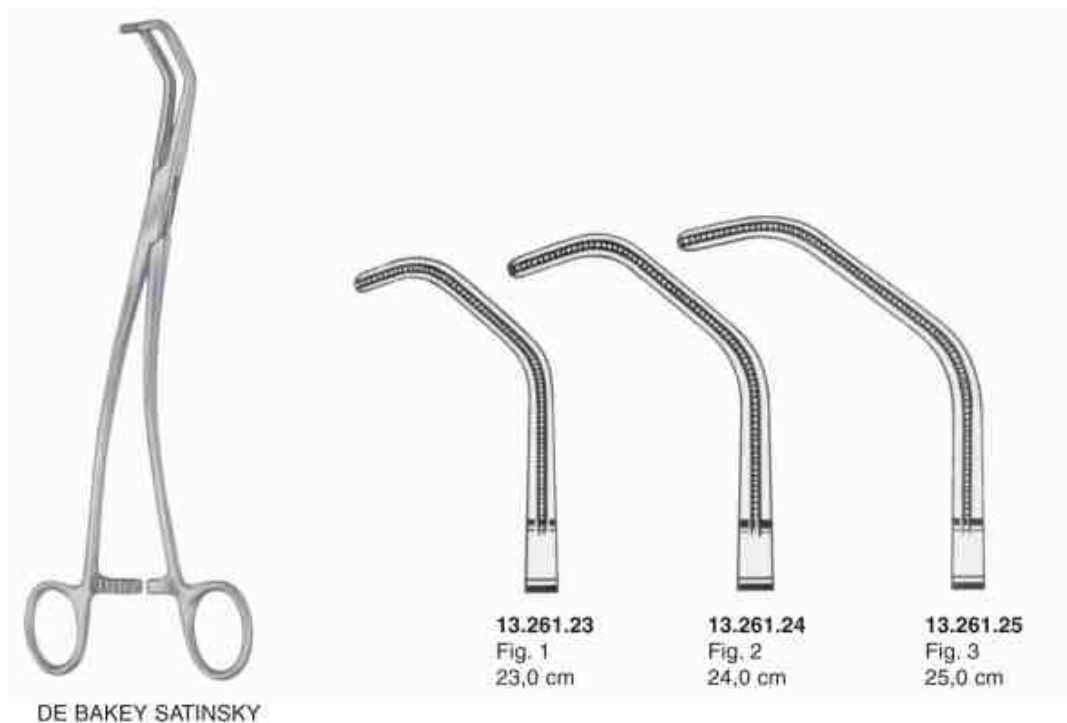

Atraumatische Gefäßklemmen
Atraumatic Hemostatic Forceps
Pincès hémostatiques atraumatiques
Pinzas hemostáticas atraumáticas
Pinze emostatiche atraumatiche

PROFIT[®]
Surgical Instruments

Aurikelklemmen
Auricle Clamps
Pincès auriculaires
Pinzas para aurícula
Pinze ventricolari



HARKEN



13.263.25
Fig. 1
25,0 cm



13.265.24
Fig. 2
24,0 cm



13.267.24
Fig. 3
24,0 cm

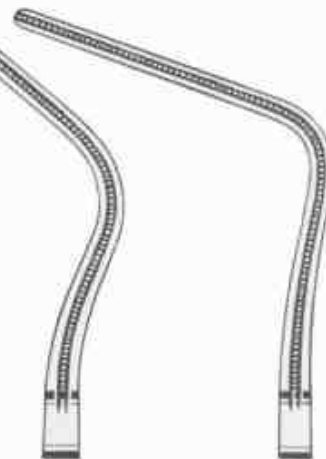

13.269.24
Fig. 4
24,0 cm

Atraumatische Gefäßklemmen
Atraumatic Hemostatic Forceps
Pincés hémostatiques atraumatiques
Pinzas hemostáticas atraumáticas
Pinze emostatiche atraumatiche

PROFIT[®]
Surgical Instruments

Peripheal-Gefäßklemmen
Peripheal Vascular Clamps
Pincés-clamps, vasculaires périphériques
Pinzas para vasos periféricos
Pinze vascolari periferali



DALE
13.271.18
18,0 cm



DALE

13.273.17
17,0 cm

13.273.18
18,0 cm

13.273.19
19,0 cm

Atraumatische Gefäßklemmen
Atraumatic Hemostatic Forceps
Pinces hémostatiques atraumatiques
Pinzas hemostáticas atraumáticas
Pinze emostatiche atraumatiche

PROFIT[®]
Surgical Instruments



DE BAKEY
13.281.17
17,0 cm



BECK
13.283.17
17,0 cm

Präparier- und Ligaturklemmen
Dissecting and Ligature Clamps
Pinces à dissection et passe-fil
Pinzas de disección y para ligaduras
Pinze per dissezione e per legature

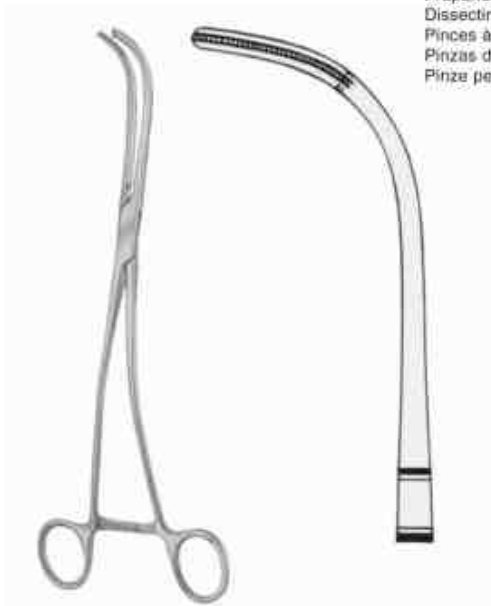

DE BAKEY
13.285.24
24,0 cm



DE BAKEY
13.287.24
24,0 cm

Atraumatische Gefäßklemmen
Atraumatic Hemostatic Forceps
Pinces hémostatiques atraumatiques
Pinzas hemostáticas atraumáticas
Pinze emostatiche atraumatiche

PROFIT[®]
Surgical Instruments

Atraumatische Mehrzweckklemmen
Atraumatic Multi-Purpose Clamps
Pinces-clamps polyvalentes
Pinzas clamps para usos varios
Pinze atraumatiche per diversi usi



Atraumatische Gefäßklemmen
Atraumatic Hemostatic Forceps
Pincès hémostatiques atraumatiques
Pinzas hemostáticas atraumáticas
Pinze emostatiche atraumatiche

PROFIT[®]
Surgical Instruments

Atraumatische Mehrzweckklemmen
Atraumatic Multi-Purpose Clamps
Pincès-clamps polyvalentes
Pinzas clamps para usos varios
Pinze atraumatiche per diversi usi



POTTS

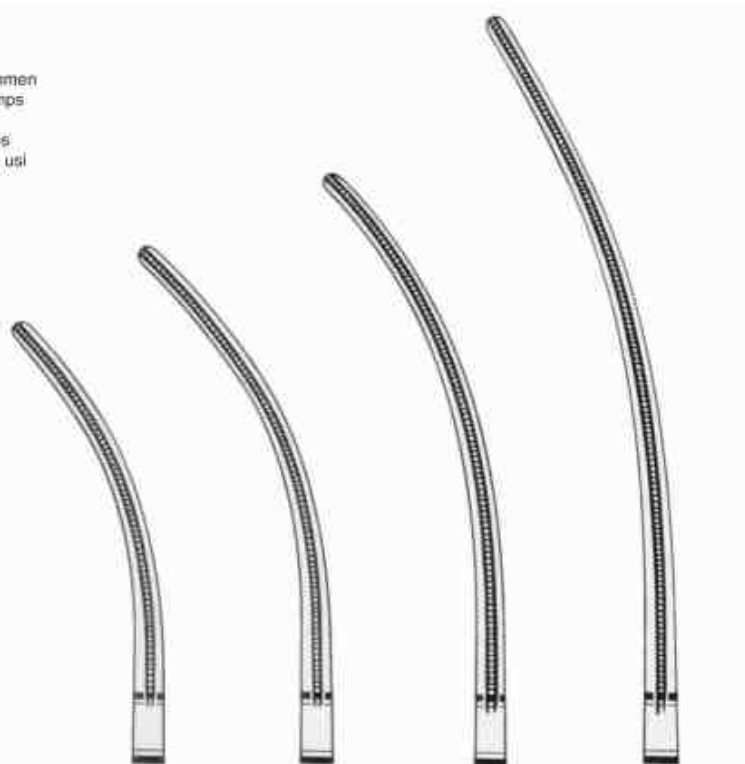

13.289.21
21,0 cm

13.289.23
23,0 cm

13.289.27
27,0 cm

13.289.31
31,0 cm

Atraumatische Gefäßklemmen
 Atraumatic Hemostatic Forceps
 Pincès hémostatiques atraumatiques
 Pinzas hemostáticas atraumáticas
 Pinze emostatiche atraumatiche

PROFIT[®]
 Surgical Instruments

Anastomosenklammern, Kindergrößen
 Anastomosis Clamps, Pediatric
 Pincès à anastomose, pédiatriques
 Pinzas para anastomosis, pediátricas
 Pinze per anastomosi, pediatriche

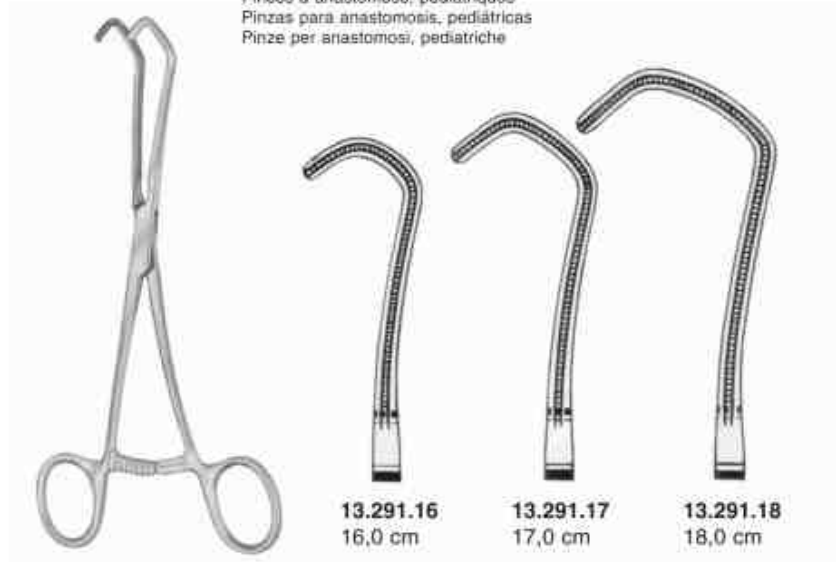

DERRA

Atraumatische Mehrzweckklemmen
 Atraumatic Multi-Purpose Clamps
 Pincès-clamps polyvalentes
 Pinzas clamps para usos varios
 Pinze atraumatiche per diversi usi



DE BAKEY
 13.302.16
 16,0 cm



DE BAKEY
 13.302.17
 17,0 cm

Atraumatische Gefäßklemmen
Atraumatic Hemostatic Forceps
Pinces hémostatiques atraumatiques
Pinzas hemostáticas atraumáticas
Pinze emostatiche atraumatiche

PROFIT[®]
Surgical Instruments



DE BAKEY
13.303.15
15,0 cm



DE BAKEY
13.307.17
17,0 cm

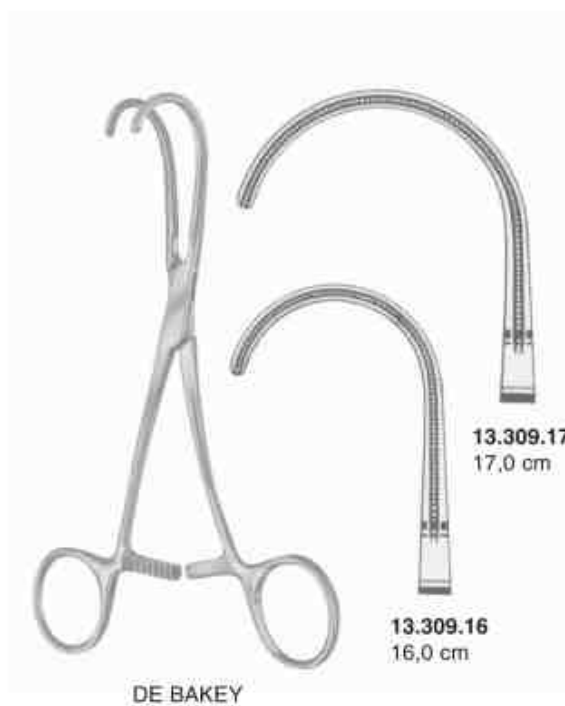

DE BAKEY

13.309.16
16,0 cm

13.309.17
17,0 cm

Atraumatische Gefäßklemmen
 Atraumatic Hemostatic Forceps
 Pincès hémostatiques atraumatiques
 Pinzas hemostáticas atraumáticas
 Pinze emostatiche atraumatiche



Atraumatische Mehrzweckklemmen
 Atraumatic Multi-Purpose Clamps
 Pincès-clamps polyvalentes
 Pinzas clamps para usos varios
 Pinze atraumatiche per diversi usi



DE BAKEY

13.311.14
14,0 cm

13.311.15
15,0 cm

13.311.16
16,0 cm

GLOVER
13.321.17
17,0 cm

Anastomosenklemmen
 Anastomosis Clamps
 Pincès à anastomose
 Pinzas para anastomosis
 Pinze per anastomosi

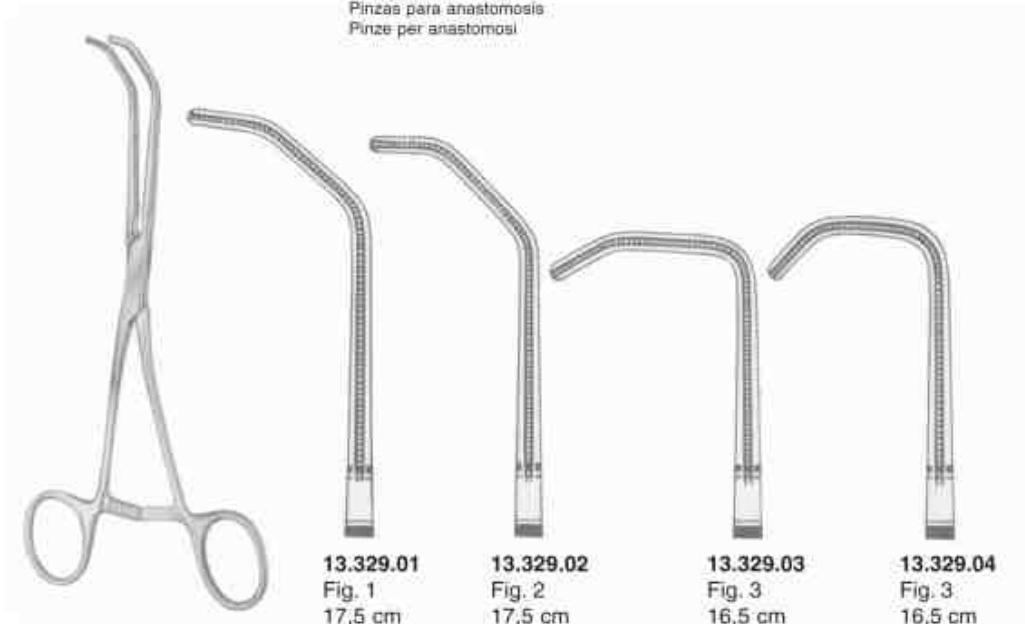

DE BAKEY REYNOLDS

13.329.01
Fig. 1
17,5 cm

13.329.02
Fig. 2
17,5 cm

13.329.03
Fig. 3
16,5 cm

13.329.04
Fig. 3
16,5 cm

Atraumatische Gefäßklemmen
Atraumatic Hemostatic Forceps
Pinces hémostatiques atraumatiques
Pinzas hemostáticas atraumáticas
Pinze emostatiche atraumatiche

PROFIT[®]
Surgical Instruments



SUBRAMANIAN
13.331.15
15,0 cm



SUBRAMANIAN
13.333.16
16,0 cm



SUBRAMANIAN
13.335.16
16,0 cm



OCHSNER
13.337.23
23,0 cm

Aortaklemmen
Aortic Clamp
Pince-clamp à aorte
Pinza clamp para aorta
Pinza per aorta



DIETRICH
13.339.21
21,0 cm

Atraumatische Gefäßklemmen
 Atraumatic Hemostatic Forceps
 Pincas hémostatiques atraumatiques
 Pinzas hemostáticas atraumáticas
 Pinze emostatiche atraumatiche

PROFIT[®]
 Surgical Instruments

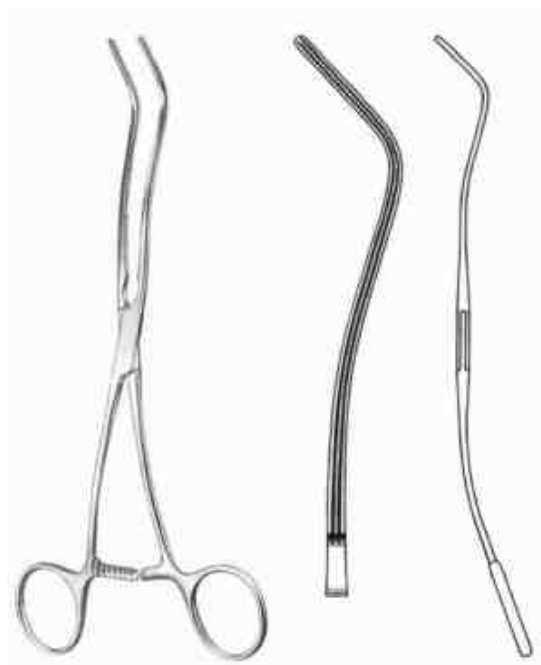

DE BAKEY
13.341.20
 20,0 cm

Präparier- und Ligaturklemmen
 Dissecting and Ligature Clamps
 Pincas à dissection et passe-fil
 Pinzas de disección y para ligaduras
 Pinze per dissezione e per legature



DE BAKEY

13.341.19
 19,0 cm

13.341.23
 23,0 cm

Carotis-Shuntklemmen
 Carotid Shunt Clamps
 Pincas pour carotide
 Pinzas para shunt carotídeo
 Pinze carotis



JAVID
13.343.18
 18,0 cm



JAVID
13.343.19
 19,0 cm

Atraumatische Gefäßklemmen
 Atraumatic Hemostatic Forceps
 Pincès hémostatiques atraumatiques
 Pinzas hemostáticas atraumáticas
 Pinze emostatiche atraumatiche

PROFIT[®]
 Surgical Instruments



GREGORY

Profunda-Klemmen
 Profunda Clamps
 Pincès-clamps pour profunda
 Pinzas clamps para profunda
 Pinze per profunda

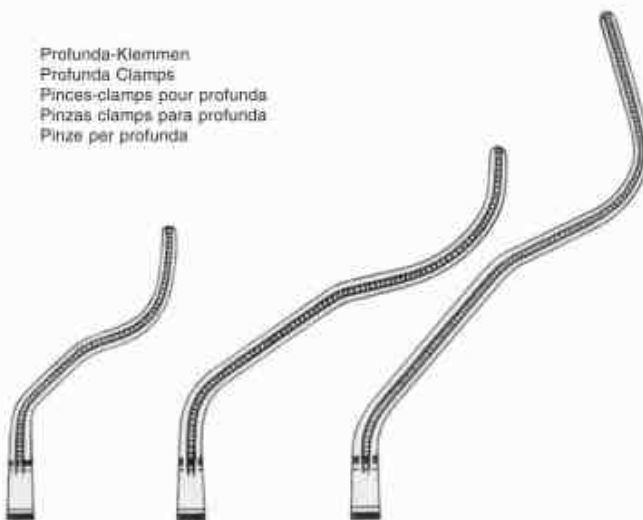

13.349.14
 14,0 cm

13.349.16
 16,0 cm

13.349.18
 18,0 cm



cm — COOLEY —
 13,0 13.350.13 13.351.13



COOLEY
 13.353.13
 13,5 cm



COOLEY
 13.355.13
 13,0 cm

Atraumatische Gefäßklemmen
Atraumatic Hemostatic Forceps
Pincès hémostatiques atraumatiques
Pinzas hemostáticas atraumáticas
Pinze emostatiche atraumatiche

PROFIT[®]
Surgical Instruments



COOLEY
13.357.12
12,5 cm



COOLEY
13.359.10
10,5 cm



COOLEY
13.361.12
12,0 cm



COOLEY
13.363.13
13,5 cm

Atraumatische Gefäßklemmen
Atraumatic Hemostatic Forceps
Pincès hémostatiques atraumatiques
Pinzas hemostáticas atraumáticas
Pinze emostatiche atraumatiche

PROFIT[®]
Surgical Instruments



COOLEY
13.357.12
12,5 cm



COOLEY
13.359.10
10,5 cm



COOLEY
13.361.12
12,0 cm



COOLEY
13.363.13
13,5 cm

Atraumatische Gefäßklemmen
 Atraumatic Hemostatic Forceps
 Pincés hémostatiques atraumáticos
 Pinzas hemostáticas atraumáticas
 Pinze emostatiche atraumatiche

PROFIT[®]
 Surgical Instruments

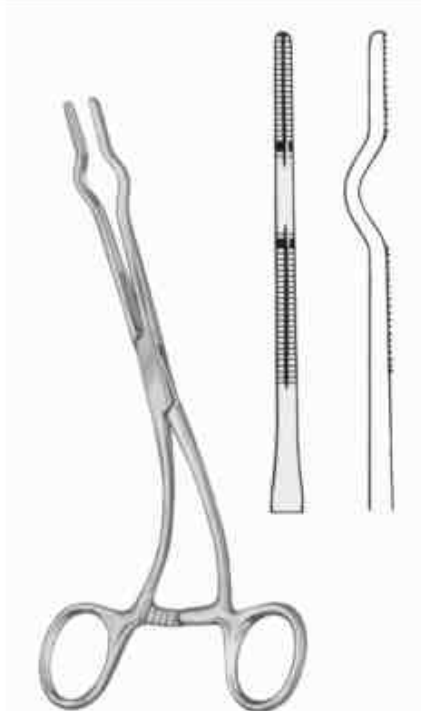

Fr./Charrière	COOLEY
24	13.371.24
26	13.371.26
28	13.371.28
30	13.373.30
32	13.373.32
36	13.373.36



cm	COOLEY	
14,0	13.376.14	13.377.14
16,0	13.376.16	13.377.16



COOLEY
 13.379.14
 14,0 cm



COOLEY
 13.380.14
 14,0 cm



COOLEY
 13.381.14
 14,0 cm

Atraumatische Gefäßklemmen
Atraumatic Hemostatic Forceps
Pinces hémostatiques atraumatiques
Pinzas hemostáticas atraumáticas
Pinze emostatiche atraumatiche

PROFIT[®]
Surgical Instruments



COOLEY
13.405.27
27,0 cm



COOLEY
13.410.17
17,0 cm

Atraumatische Gefäßklemmen
 Atraumatic Hemostatic Forceps
 Pincès hémostatiques atraumatiques
 Pinzas hemostáticas atraumáticas
 Pinze emostatiche atraumatiche

PROFIT[®]
 Surgical Instruments

Atraumatische Mehrzweckklemmen
 Atraumatic Multi-Purpose Clamps
 Pincès-clamps polyvalentes
 Pinzas clamps para usos varios
 Pinze atraumatiche per diversi usi



13.411.17
17,0 cm

13.413.17
17,0 cm

13.416.17
17,0 cm

COOLEY

Iliaca-Klemmen
 Iliac Clamps
 Pincès-clamps à iliaque
 Pinzas clamps para ilíaca
 Pinze per ilíaca



COOLEY
13.417.21
21,5 cm

Anastomosenklemmen
 Anastomosis Clamps
 Pincès à anastomose
 Pinzas para anastomosis
 Pinze per anastomosi



COOLEY
13.419.17
17,0 cm

Atraumatische Gefäßklemmen
 Atraumatic Hemostatic Forceps
 Pincas hémostatiques atraumatiques
 Pinzas hemostáticas atraumáticas
 Pinze emostatiche atraumatiche

PROFIT[®]
 Surgical Instruments



Atraumatische Gefäßklemmen
 Atraumatic Hemostatic Forceps
 Pinces hémostatiques atraumatiques
 Pinzas hemostáticas atraumáticas
 Pinze emostatiche atraumatiche



Atraumatische Mehrzweckklemmen
 Atraumatic Multi-Purpose Clamps
 Pinces-clamps polyvalentes
 Pinzas clamps para usos varios
 Pinze atraumatiche per diversi usi



COOLEY
 13.431.25
 16,5 cm



COOLEY
 13.431.45
 16,5 cm

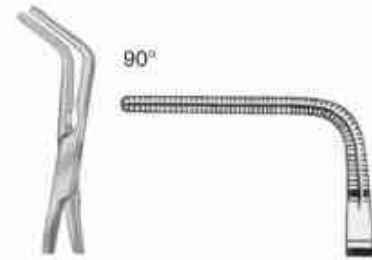

COOLEY
 13.431.90
 16,5 cm

Anastomosenklemmen
 Anastomosis Clamps
 Pinces à anastomose
 Pinzas para anastomosis
 Pinze per anastomosi



COOLEY
 13.433.14
 14,0 cm



COOLEY DERRA



13.441.16
 16,0 cm



13.441.17
 17,0 cm

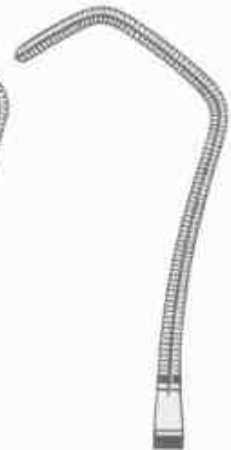

13.441.18
 18,0 cm

Atraumatische Gefäßklemmen
 Atraumatic Hemostatic Forceps
 Pincès hémostatiques atraumatiques
 Pinzas hemostáticas atraumáticas
 Pinze emostatiche atraumatiche



Anastomosenklemmen
 Anastomosis Clamps
 Pincès à anastomose
 Pinzas para anastomosis
 Pinze per anastomosi

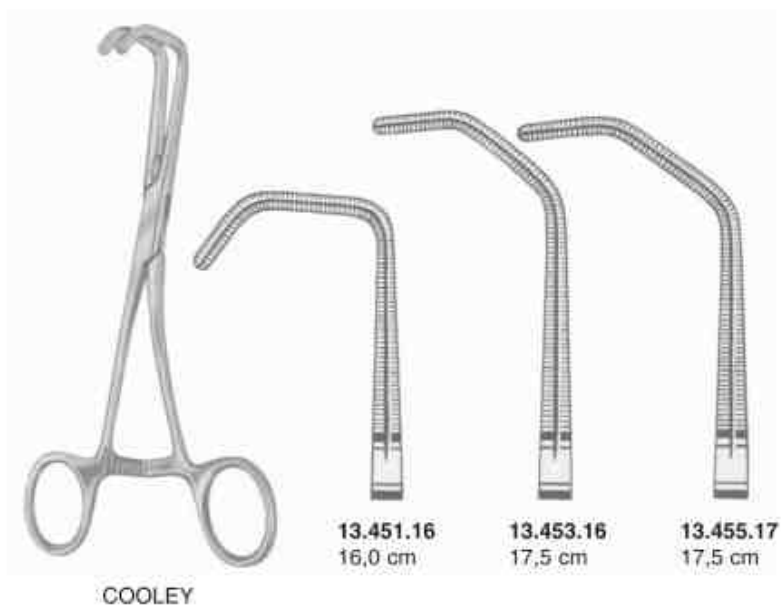
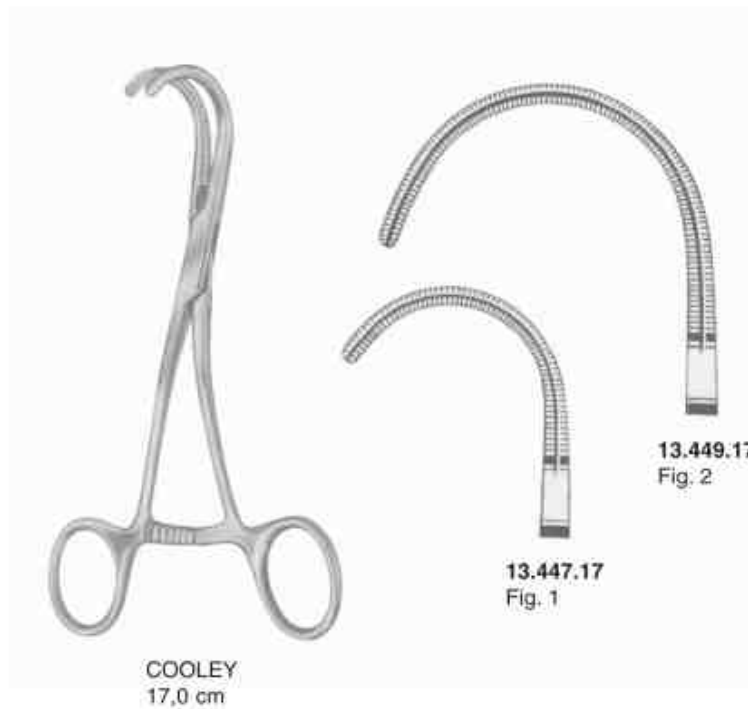

Atraumatische Gefäßklemmen
Atraumatic Hemostatic Forceps
Pinces hémostatiques atraumatiques
Pinzas hemostáticas atraumáticas
Pinze emostatiche atraumatiche

PROFIT[®]
Surgical Instruments



COOLEY
13.457.17
17,0 cm



COOLEY
13.461.17
17,0 cm



COOLEY
13.465.18
18,0 cm



COOLEY
13.465.19
19,0 cm



COOLEY
13.465.26
26,0 cm



COOLEY
13.467.27
27,0 cm

Atraumatische Gefäßklemmen
 Atraumatic Hemostatic Forceps
 Pincès hémostatiques atraumatiques
 Pinzas hemostáticas atraumáticas
 Pinze emostatiche atraumatiche



Neonatal- und Kinderklemmen, extra feine Modelle:
 Neonatal and Childrens Clamps, extra delicate patterns
 Pincès-clamps pour des nouveaux-nés et des enfants, modèles très fins
 Pinzas clamps para recién nacidos y niños, modelos muy finos
 Pinze pediatriche, modelli molto fini

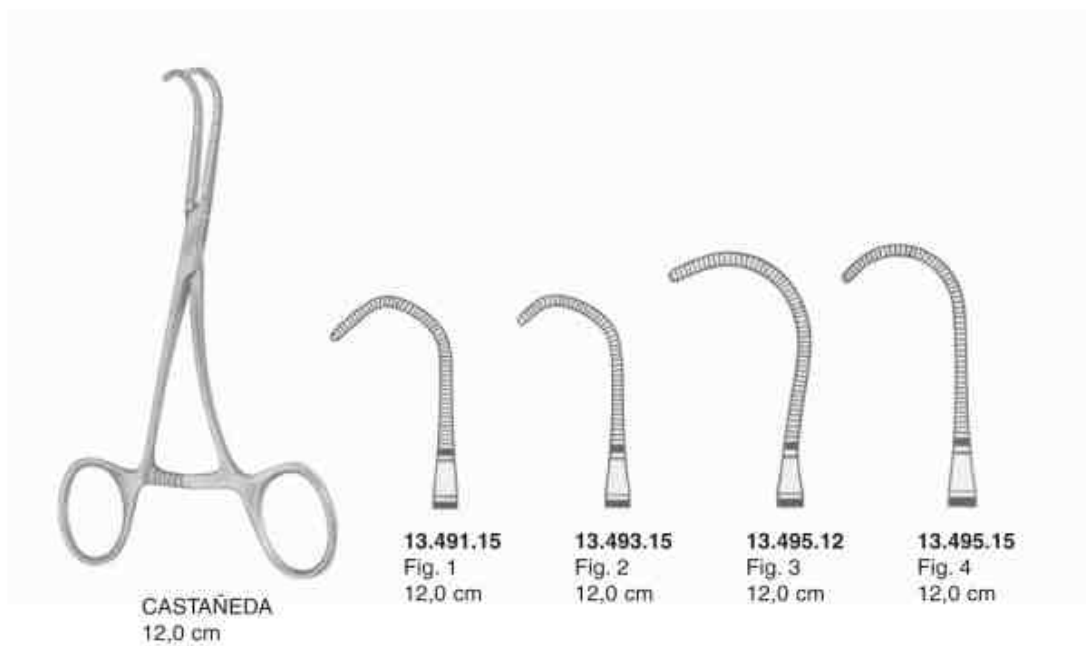
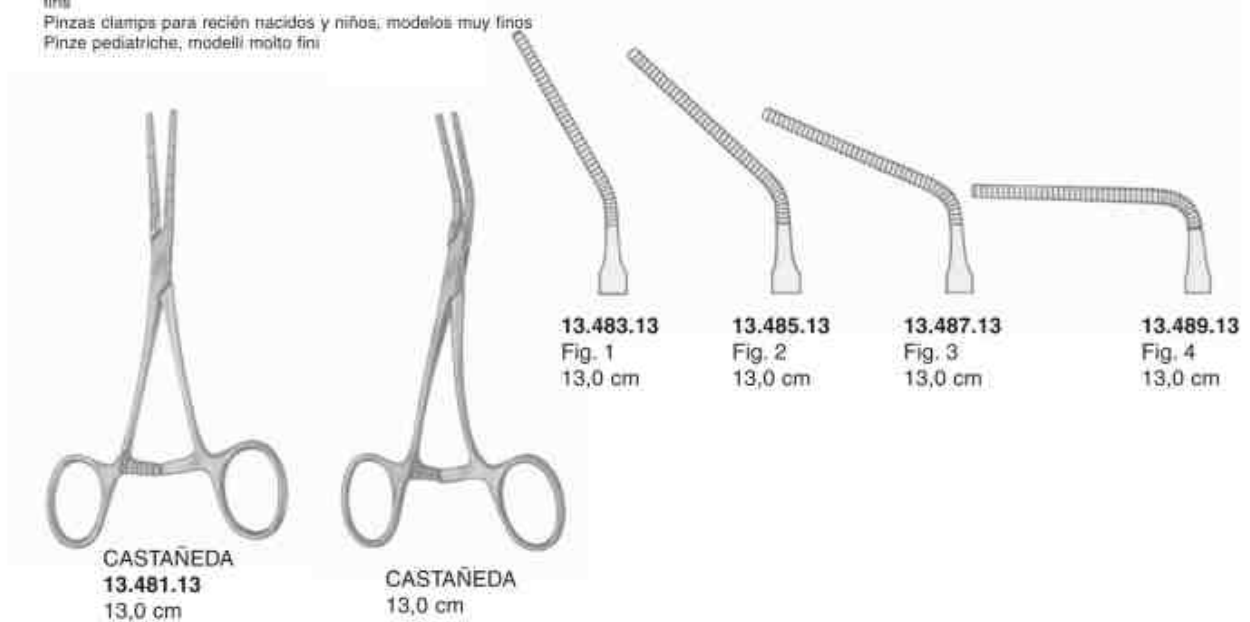

Atraumatische Gefäßklammen
 Atraumatic Hemostatic Forceps
 Pinces hémostatiques atraumatiques
 Pinzas hemostáticas atraumáticas
 Pinze emostatiche atraumatiche



Kinder-Gefäßklammen
 Pediatric Vascular Clamp
 Pinces vasculaires pédiatriques
 Pinzas vasculares pediátricas
 Pinze vascolari pediatriche



gerade
 straight
 droites
 rectas
 rette

13.502.01 - 13.502.09
 Fig. 1-9



abgewinkelt
 angled
 coudées
 acodadas
 angolari

13.503.01 - 13.503.09
 Fig. 1-9



stark abgewinkelt
 strongly angled
 fortement coudées
 fuertemente acodadas
 fortemente angolari

13.505.01 - 13.505.09
 Fig. 1-9



Fig. 1

13.502.01
 13.503.01
 13.505.01



Fig. 2

13.502.02
 13.503.02
 13.505.02



Fig. 3

13.502.03
 13.503.03
 13.505.03



Fig. 4

13.502.04
 13.503.04
 13.505.04



Fig. 5

13.502.05
 13.503.05
 13.505.05



Fig. 6

13.502.06
 13.503.06
 13.505.06



Fig. 7

13.502.07
 13.503.07
 13.505.07



Fig. 8

13.502.08
 13.503.08
 13.505.08



Fig. 9

13.502.09
 13.503.09
 13.505.09