

HAEMOSTATIC FORCEPS

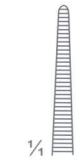

04-001-100 10 cm
Straight, serrated

HARTMANN / MOSQUITO

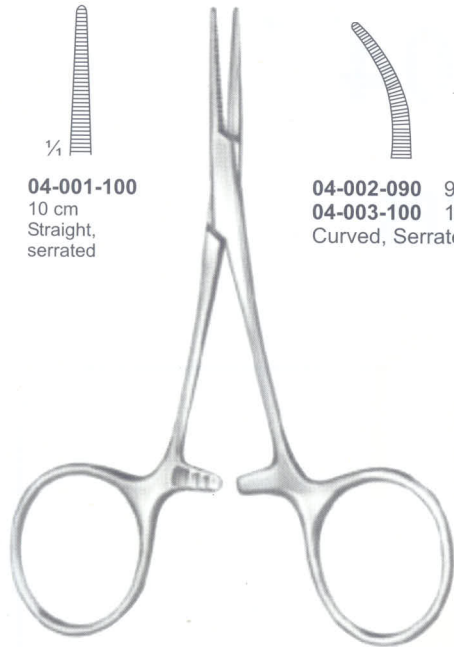

04-002-090 9.0 cm
04-003-100 10 cm
Curved, Serrated

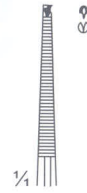
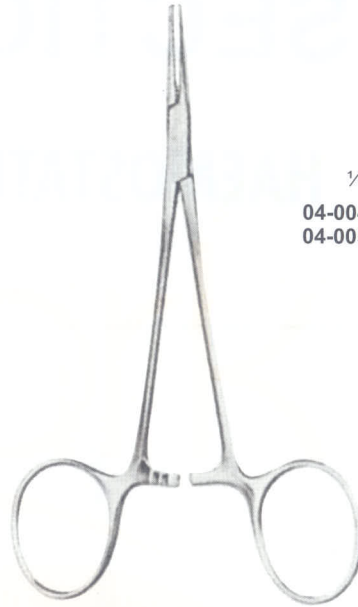

04-004-100 10 cm
04-005-120 12 cm

KOCHER MOSQUITO 1:2

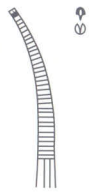

04-006-100 10 cm
04-007-120 12 cm



HALSTED-MOSQUITO



04-008-125 12.5 cm
04-009-140 14.0 cm
straight, serrated



04-010-180 18 cm
straight, serrated



04-011-210 21 cm
straight, serrated



04-012-125 12.5 cm
04-013-140 14.0 cm
Curved, serrated



04-114-180 18 cm
Curved, serrated

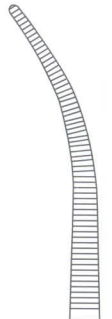

04-115-205 20.5 cm
Curved, serrated

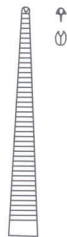

04-016-125 12.5 cm
04-017-140 14.0 cm
Straight, 1:2 Teeth

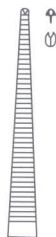

04-018-180 18 cm
Straight, 1:2 Teeth

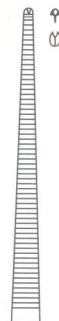

04-019-210 21 cm
Straight, 1:2 Teeth



04-020-125 12.5 cm
04-021-140 14.0 cm
Curved, 1:2 Teeth



04-022-180 18 cm
Curved, 1:2 Teeth

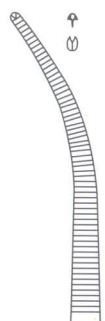

04-023-205 20.5 cm
Curved, 1:2 Teeth

HAEMOSTATIC FORCEPS

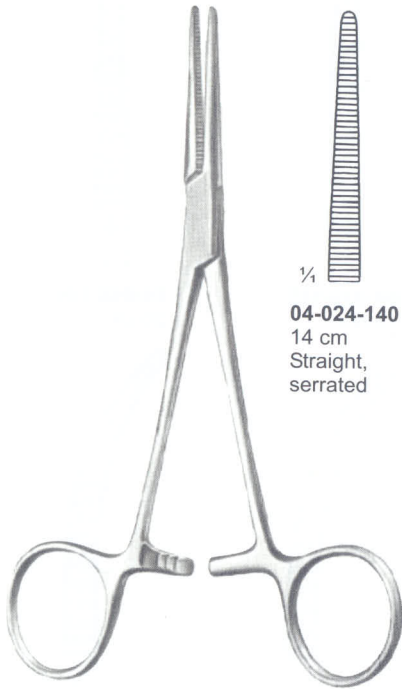

04-024-140
14 cm
Straight,
serrated

CRILE



04-025-140
14 cm
Curved,
serrated



04-026-140
14 cm
Straight,
1:2 Teeth



04-027-140
14 cm
Curved,
1:2 Teeth

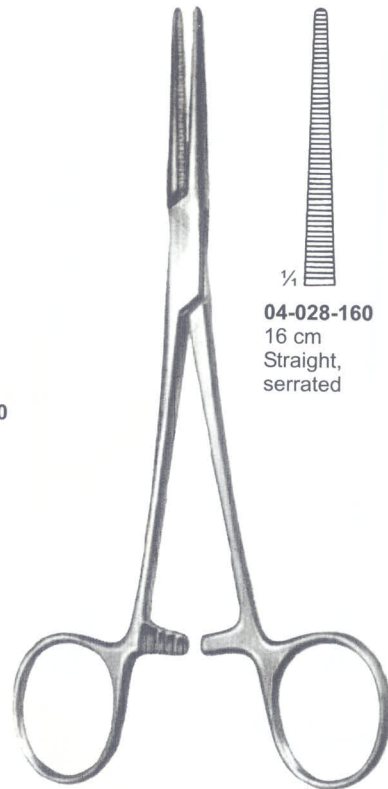

04-028-160
16 cm
Straight,
serrated

CRILE-RANKIN



04-029-160
16 cm
Curved,
serrated

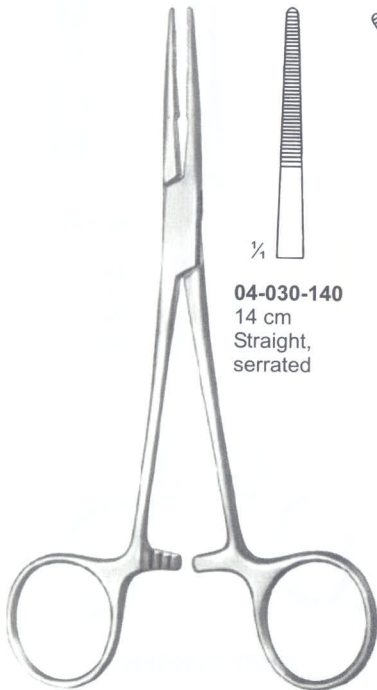

04-030-140
14 cm
Straight,
serrated

KELLY



04-031-140
14 cm
Curved,
serrated

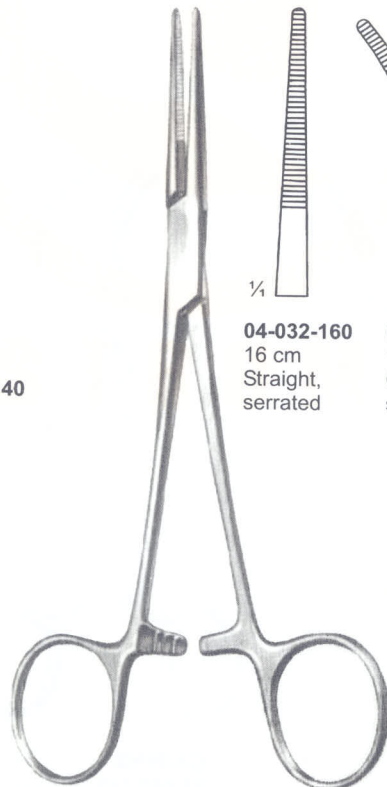

04-032-160
16 cm
Straight,
serrated

KELLY-RANKIN



04-033-160
16 cm
Curved,
serrated

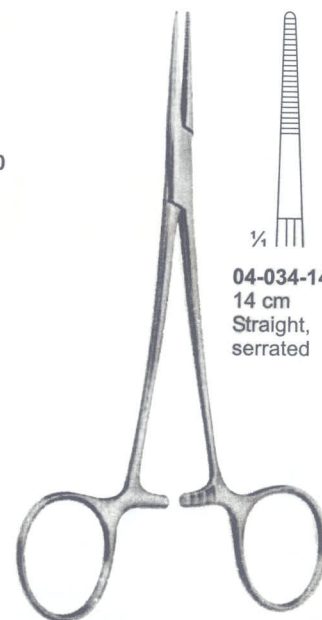

04-034-140
14 cm
Straight,
serrated

PROVIDENCE / HOSPITAL



04-035-140
14 cm
Curved,
serrated

HAEMOSTATIC FORCEPS



SPENCER-WELLS



04-036-130
13 cm



04-037-140
14 cm



04-038-155
15.5 cm



04-039-180
18 cm

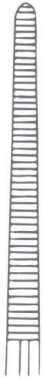

04-040-200
20 cm



04-041-130
13 cm



04-042-140
14 cm



04-043-155
15.5 cm



04-044-180
18 cm



04-045-200
20 cm

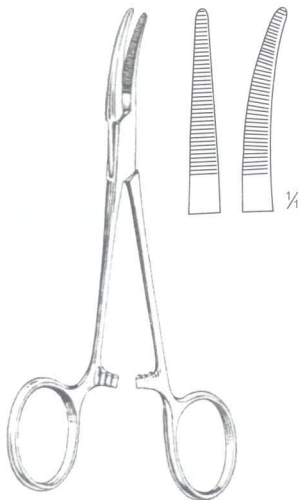

DUNHILL
04-046-130 13.0 cm
Straight, box joint,
as above but curved on flat.

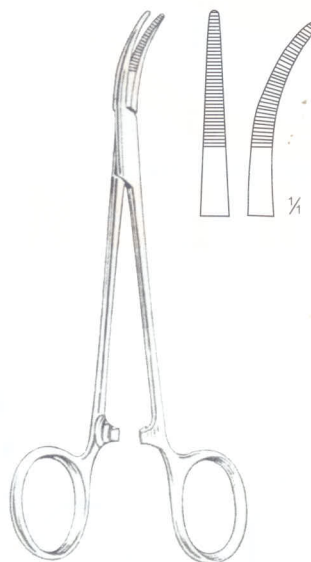

CAIRNS
04-047-145 14.5 cm
Straight, box joint,
as above but curved on flat.

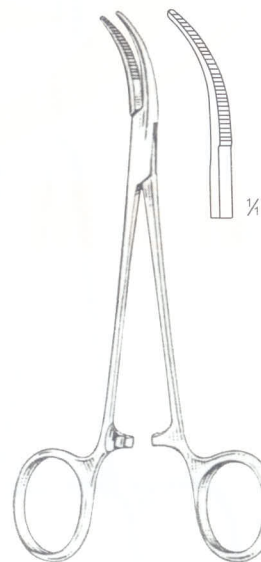

CAIRNS
04-048-145 14.5 cm
curved laterally, joint

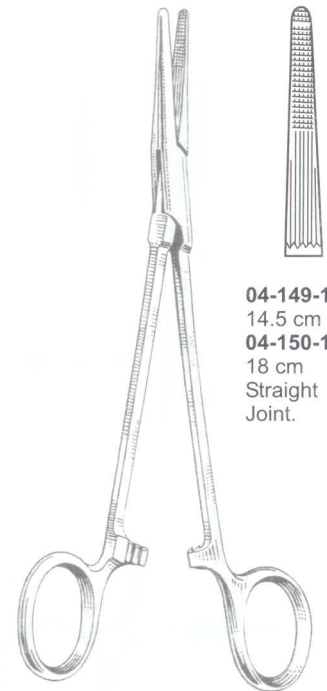

04-149-145
14.5 cm
04-150-180
18 cm
Straight
Joint.

HAEMOSTATIC FORCEPS



CRAFOORD-SELLORS



ROBERTS

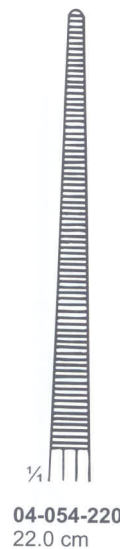

HEISS
20.0 cm

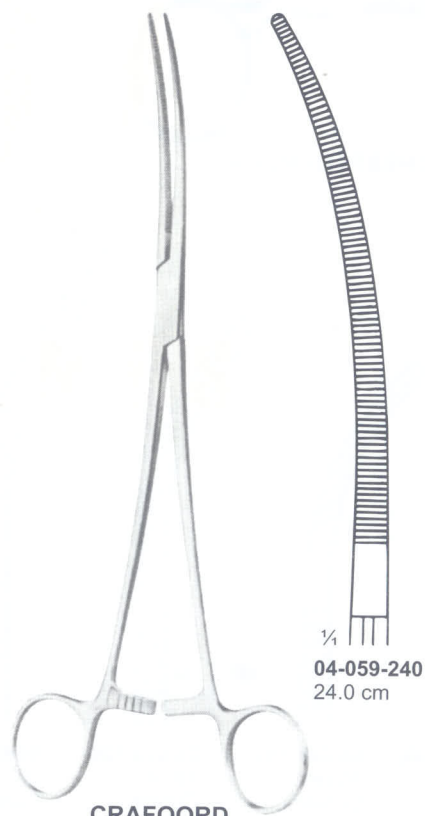

CRAFOORD

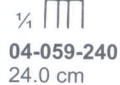

HAEMOSTATIC FORCEPS

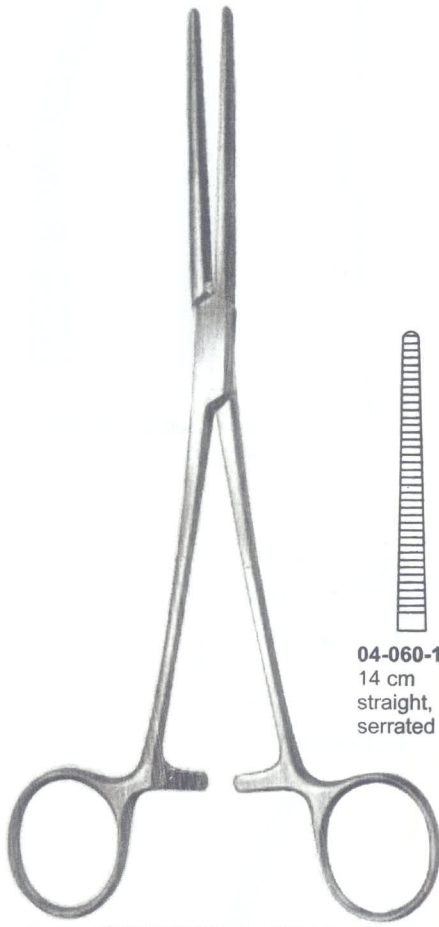

ROCHESTER / PEAN

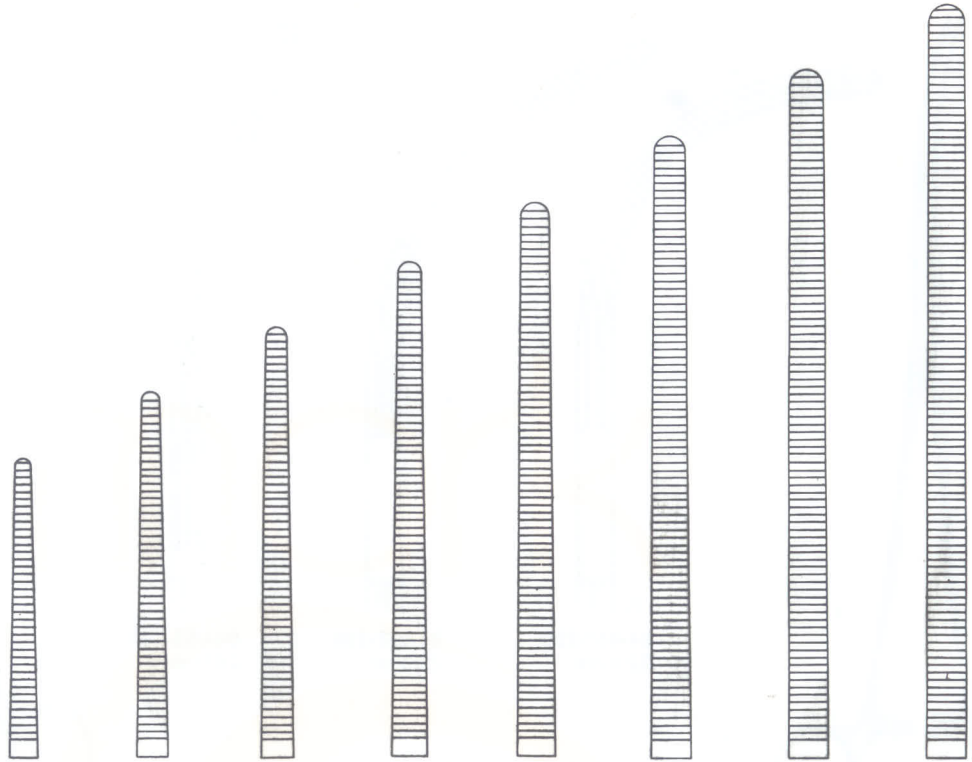

- 04-060-140**
14 cm
straight,
serrated
- 04-061-160**
16 cm
straight,
serrated
- 04-062-180**
18 cm
straight,
serrated
- 04-063-200**
20 cm
straight,
serrated
- 04-064-220**
22 cm
straight,
serrated
- 04-065-240**
24 cm
straight,
serrated
- 04-066-260**
26 cm
straight,
serrated
- 04-067-300**
30 cm
straight,
serrated

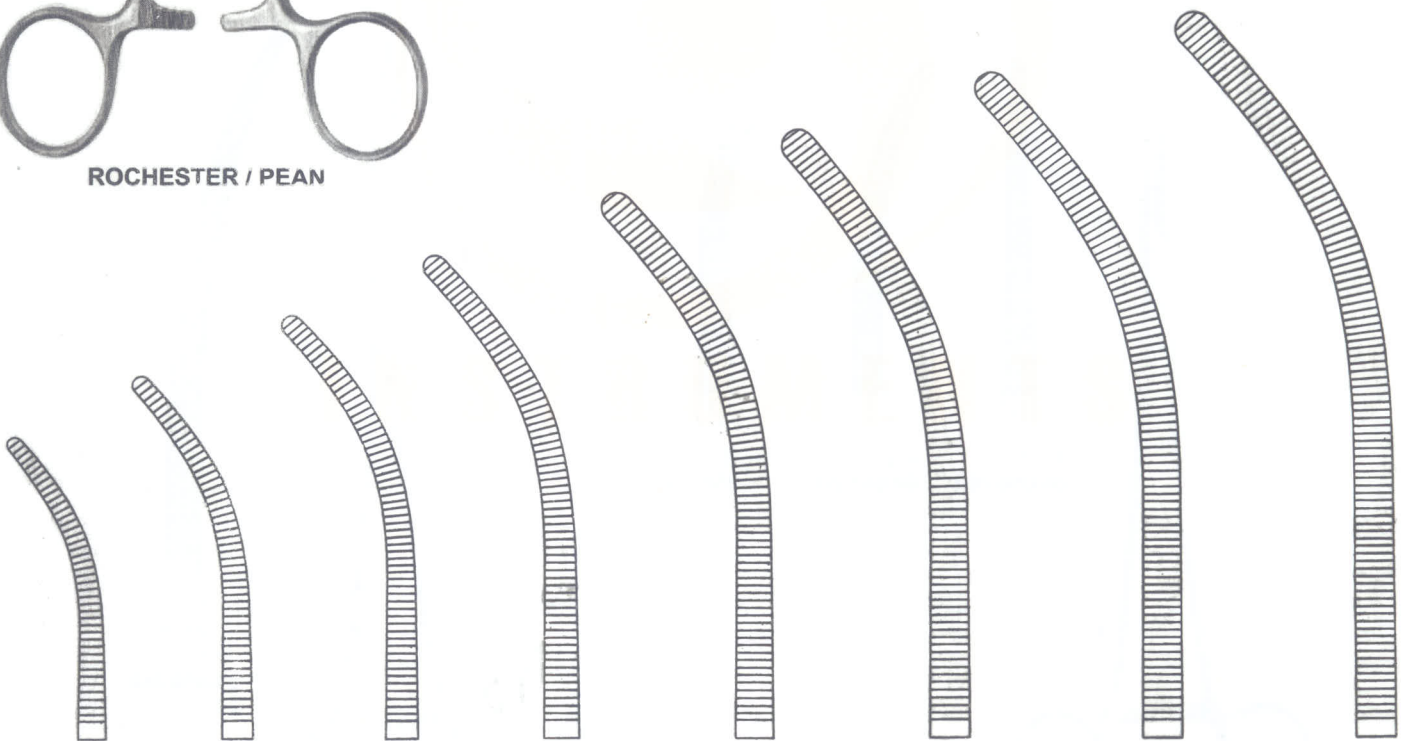

- 04-068-140**
14 cm
Curved,
serrated
- 04-069-160**
16 cm
Curved,
serrated
- 04-070-180**
18 cm
Curved,
serrated
- 04-071-200**
20 cm
Curved,
serrated
- 04-072-220**
22 cm
Curved,
serrated
- 04-073-240**
24 cm
Curved,
serrated
- 04-074-260**
26 cm
Curved,
serrated
- 04-075-300**
30 cm
Curved,
serrated

HAEMOSTATIC FORCEPS



KOCHER / DELICATE

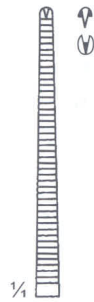

04-076-130 13 cm
04-077-140 14 cm
04-078-160 16 cm
Straight, 1:2 Teeth



04-079-140 14 cm
14 cm
curved,
1:2 Teeth



04-080-160 16 cm
04-081-200 20 cm
Straight,
Cross Serrated



04-082-160 16 cm
04-083-200 20 cm
Curved,
Cross Serrated

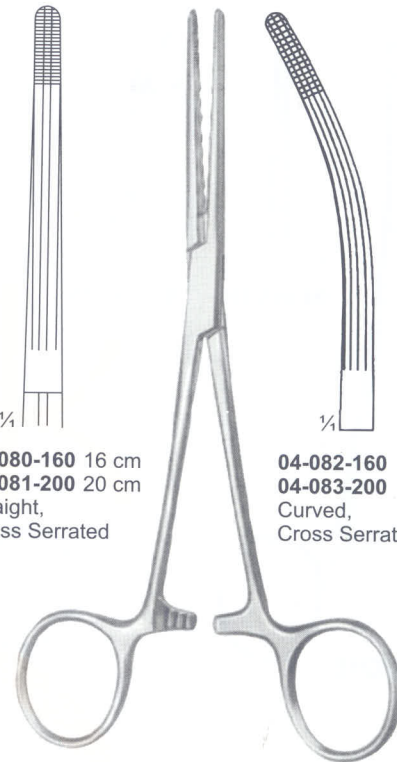

ROCHESTER / CARMALT



PEAN - DELICATE

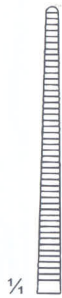

04-084-140 14 cm
04-085-160 16 cm
04-086-180 18 cm
Straight, Serrated



04-087-140 14 cm
04-088-160 16 cm
04-089-180 18 cm
Curved, Serrated

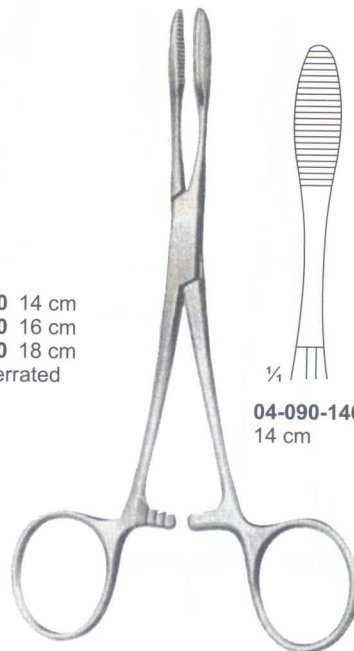

PEAN

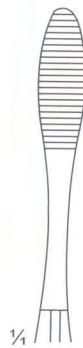

04-090-140 14 cm



04-091-160 16 cm

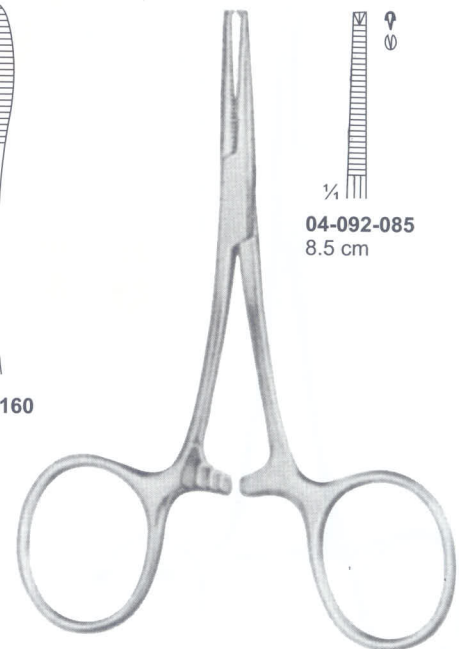

TERRIER 1:2

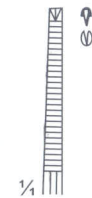

04-092-085 8.5 cm

HAEMOSTATIC FORCEPS

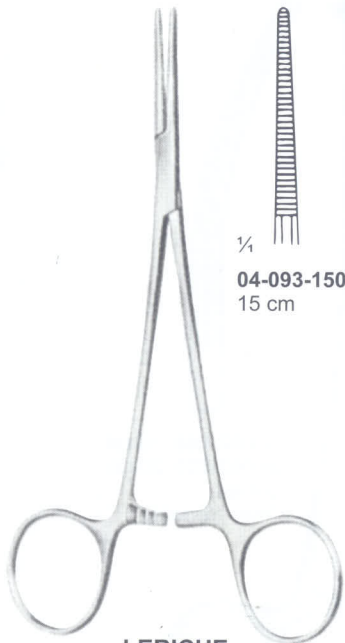

¼
04-093-150
15 cm

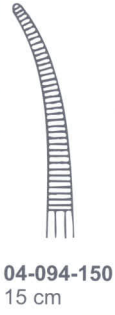

04-094-150
15 cm

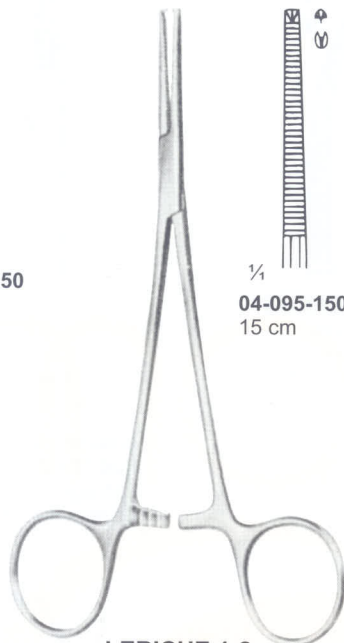

¼
04-095-150
15 cm

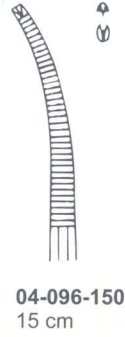

04-096-150
15 cm

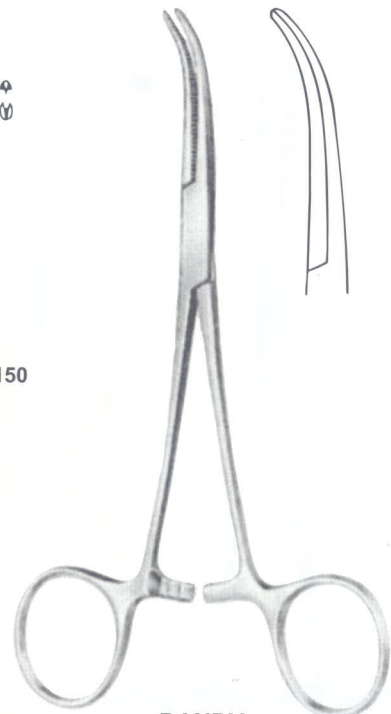

¼
04-097-140
14 cm

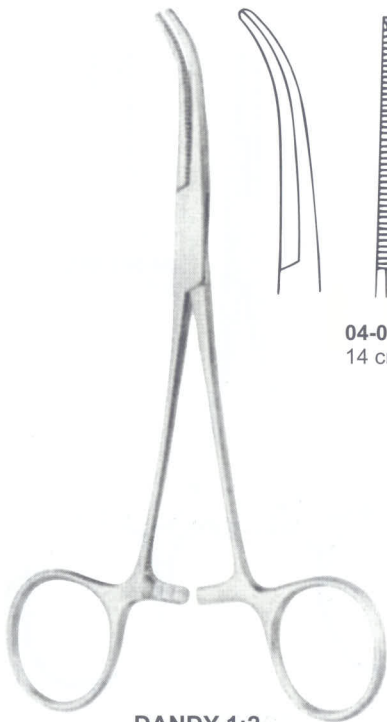

¼
04-098-140
14 cm

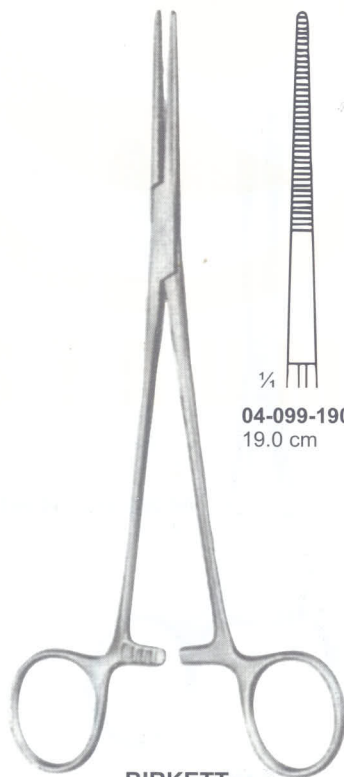

¼
04-099-190
19.0 cm



04-100-190
19.0 cm

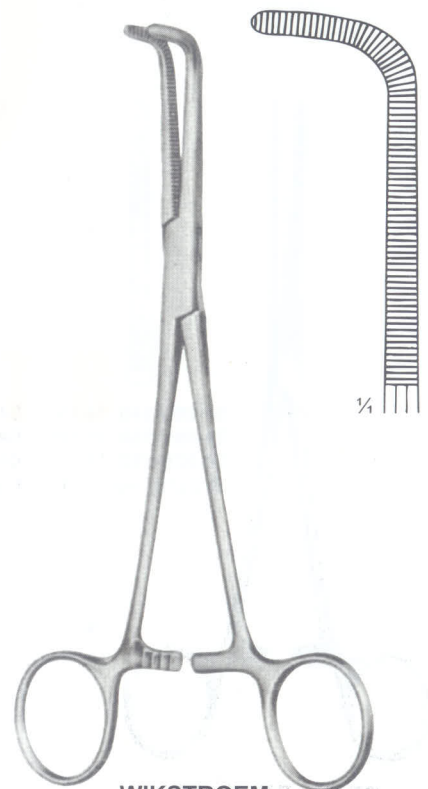

WIKSTROEM
04-101-190
19.0 cm

HAEMOSTATIC FORCEPS



04-102-140
14 cm
curved,
serrated

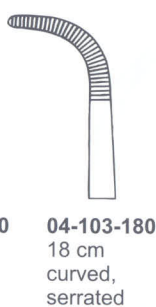

04-103-180
18 cm
curved,
serrated

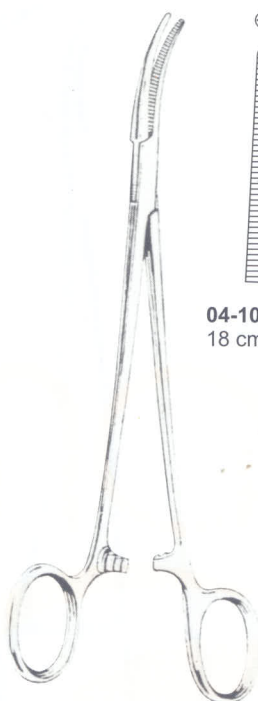

04-104-180
18 cm

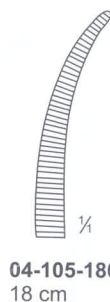

04-105-180
18 cm



04-106-185
18.5 cm
Straight,
serrated



04-107-185
18.5 cm
curved,
serrated

BABY-ADSON

ADSON
Straight, box joint,
as above but curved flat.
Straight, box joint,
one into two teeth

ADSON



04-108-185
18.5 cm



04-109-185
18.5 cm

ADSON 1:2

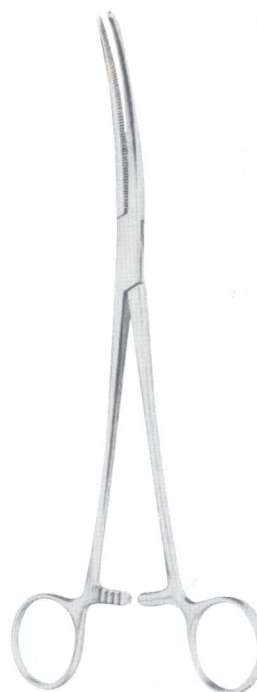

04-110-240
24 cm
Curved,
Serrated

SAROT

HAEMOSTATIC FORCEPS

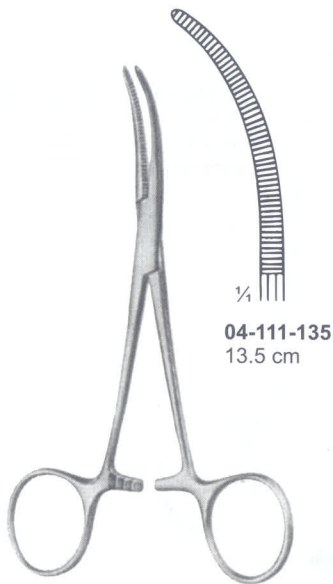

04-111-135
13.5 cm

BABY-OVERHOLT



04-112-185
18.5 cm

OVERHOLT



04-113-205
20.5 cm

OVERHOLT

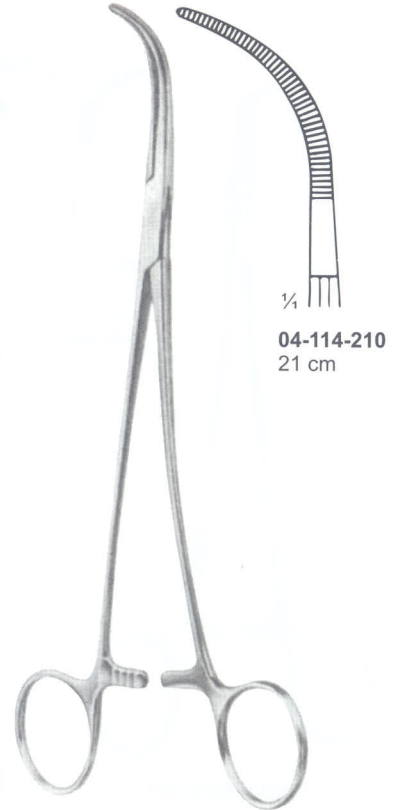

04-114-210
21 cm

OVERHOLT

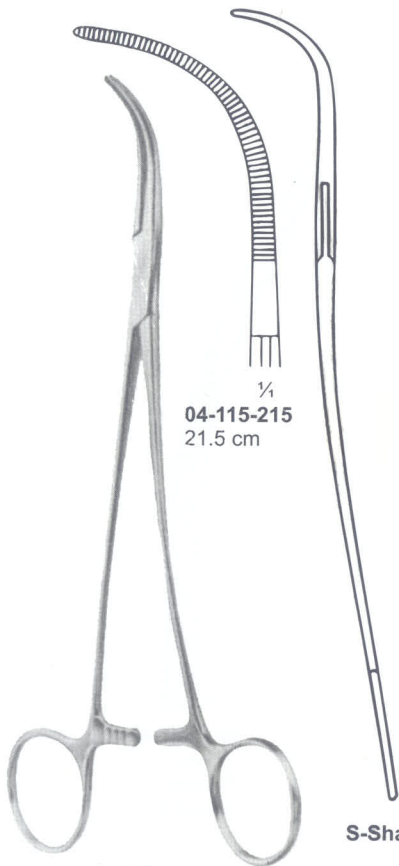

04-115-215
21.5 cm

OVERHOLT



OVERHOLT-GEISSENDOERFER



04-116-210 21cm
04-117-270 27cm



04-118-210 21 cm
04-119-270 27 cm



04-120-210 21 cm
04-121-270 27 cm

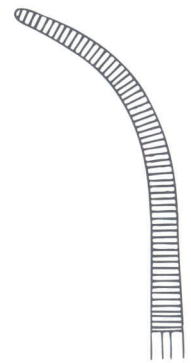

04-122-210 21 cm
04-123-270 27 cm

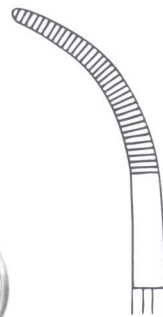

04-124-210 21 cm
04-125-270 27 cm

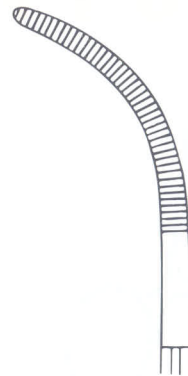

04-126-210 21 cm
04-127-270 27 cm



04-128-210 21 cm
04-129-270 27 cm

S-Shaped

HAEMOSTATIC FORCEPS

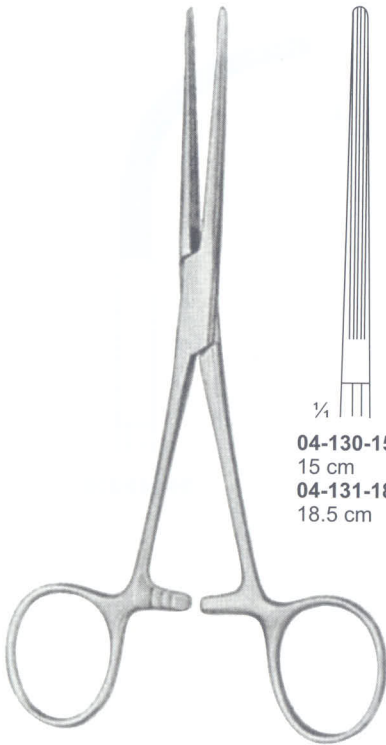

04-130-150
15 cm
04-131-185
18.5 cm

BAINBRIDGE



04-132-150
15 cm
04-133-185
18.5 cm

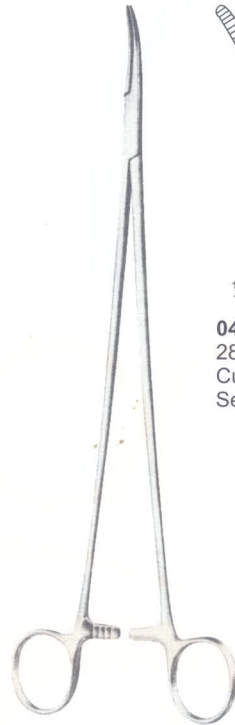

04-134-280
28 cm
Curved,
Serrated

BRIDGE



04-135-280
28.0 cm

LAWERNCE



04-136-180
18 cm
Curved,
Serrated

MINI-GEMINI



04-137-130 13 cm
04-138-180 18 cm
04-139-200 20 cm
Curved, Serrated

GEMINI

HAEMOSTATIC FORCEPS



RUMEL
23.0 cm



04-140-230



04-141-230



04-142-230



04-143-230



BENGOLEA



04-144-200
20 cm
04-145-260
26 cm



04-146-200
20 cm
04-147-260
26 cm



BENGOLEA 1:2

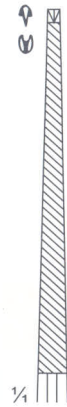

04-148-200
20 cm
04-149-260
26 cm

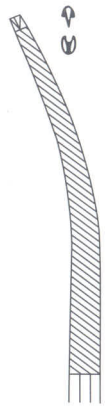

04-150-200
20 cm
04-151-260
26 cm

HAEMOSTATIC FORCEPS



MOYNIHAN

04-152-230
23.0 cm

04-153-240
24.0 cm

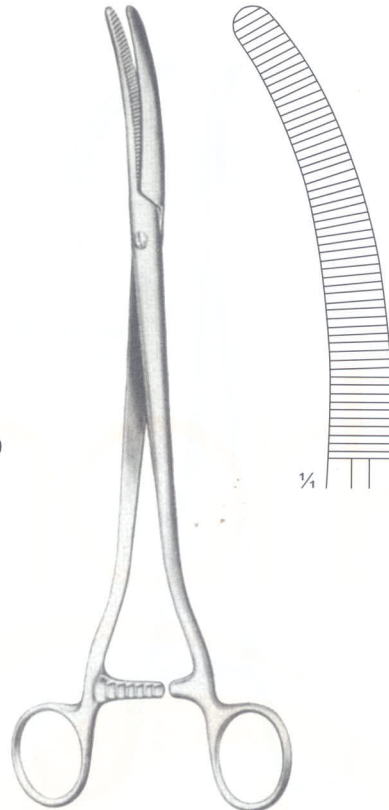

FAURE
04-154-250
25.0 cm

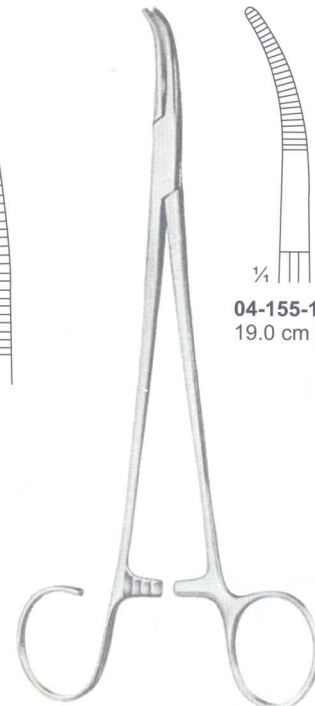

SCHNIDT-SAWTELL

04-155-190
19.0 cm

04-156-190
19.0 cm



TOENNIS

04-157-210 21.0 cm
04-158-260 26.0 cm



04-159-210 21.0 cm
04-160-260 26.0 cm



TOENNIS 1:2



04-161-210 21.0 cm
04-162-260 26.0 cm



04-163-210 21.0 cm
04-164-260 26.0 cm

HAEMOSTATIC FORCEPS

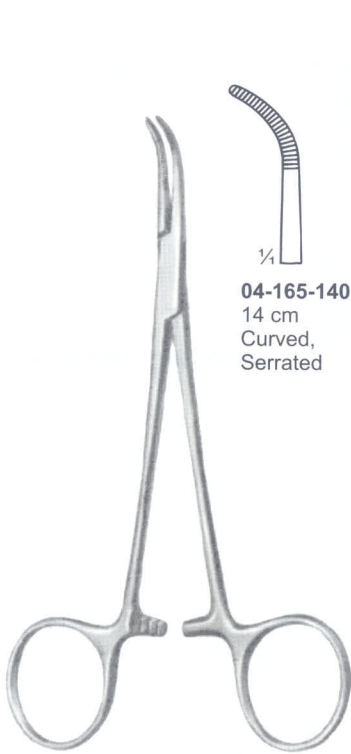

04-165-140
14 cm
Curved,
Serrated

BABY-MIXTER



04-166-180
18.0 cm

BABY-MIXTER

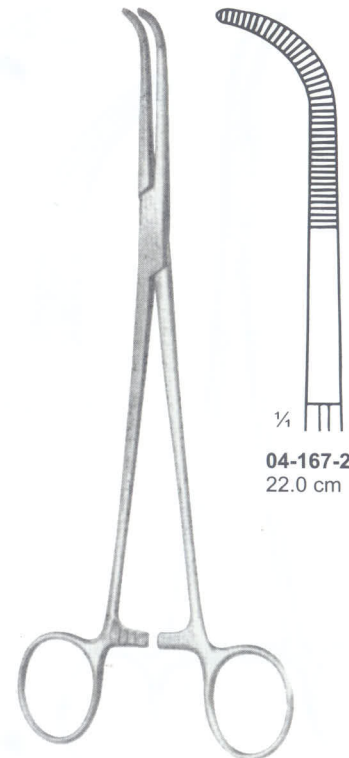

04-167-220
22.0 cm

MIXTER



04-168-210
21 cm
Right Angle
Grooves

MIXTER



04-169-155
15.5 cm
Fully Curved,
Serrated

MIXTER

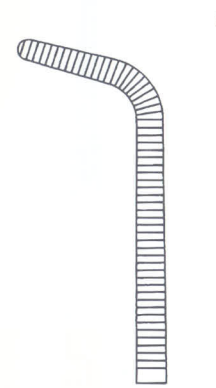

04-170-190
19 cm
Fully Curved,
Serrated

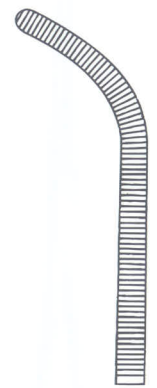

04-171-230
23 cm
Fully Curved,
Serrated

HAEMOSTATIC FORCEPS

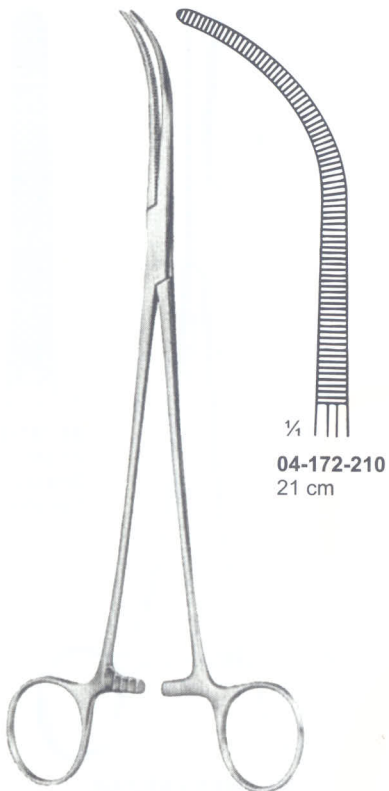

04-172-210
21 cm

OVERHOLT-MIXTER

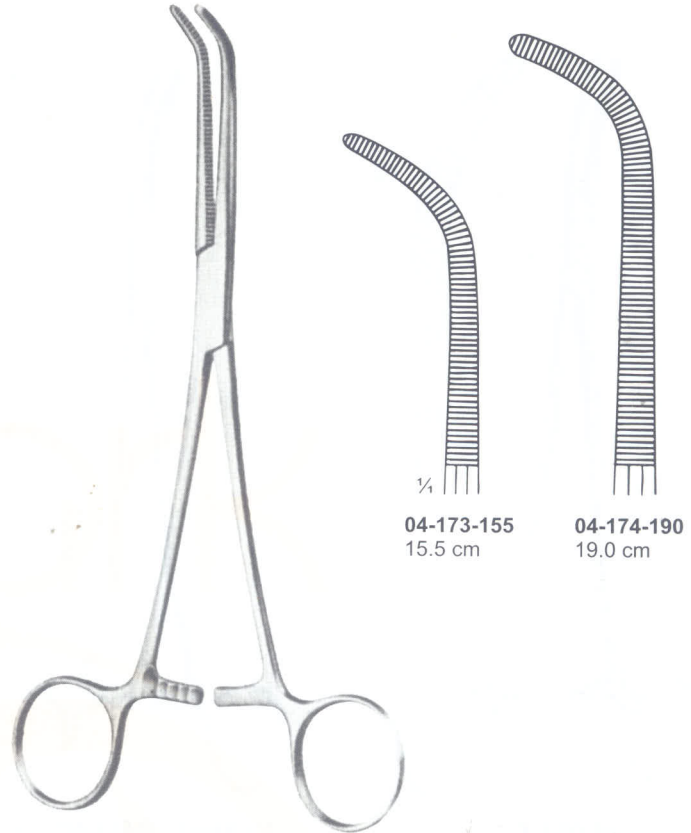

04-173-155
15.5 cm

04-174-190
19.0 cm

MIXTER-O'SHAUGHNESSY



04-175-190
19 cm
Curved,
Grooves

LAHEY

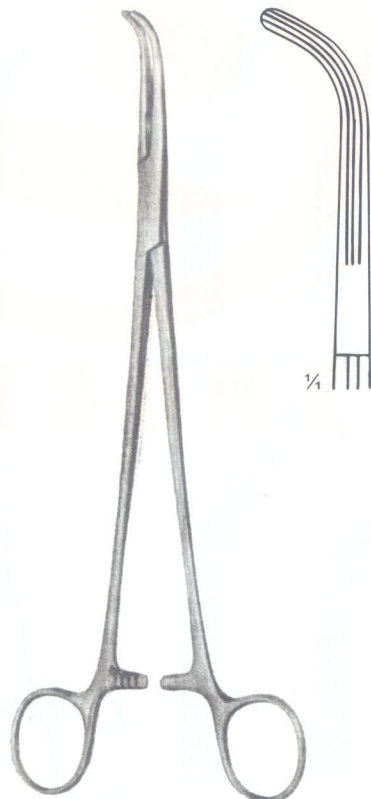

LAHEY
04-176-230
23.0 cm



04-177-180
18 cm
S Curve,
Coarse
serration

DEAN-SHALLCROSS

HAEMOSTATIC FORCEPS

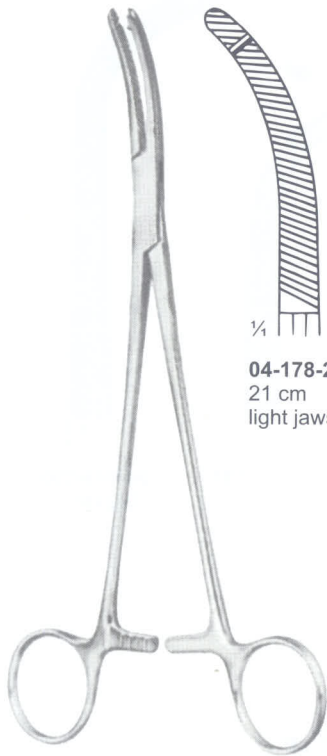

04-178-210
21 cm
light jaws

HEANEY

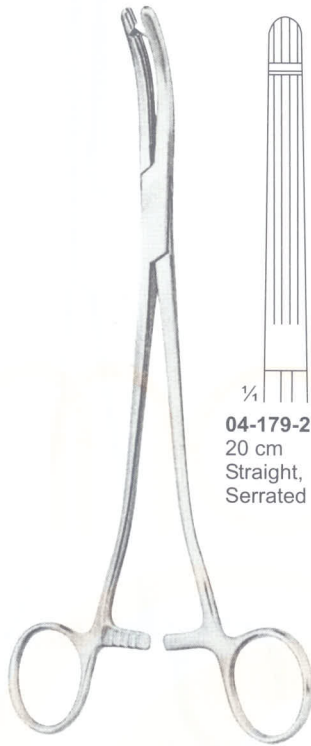

04-179-200
20 cm
Straight,
Serrated

HEANEY / BALLANTINE

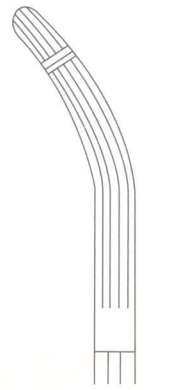

04-180-200
20 cm
Slight Curve,
Serrated

HEANEY / REZAK



04-181-210
21 cm
Straight, Cross
Serrated



HEANEY



04-182-195
19.5 cm



04-183-215
21.5 cm



04-184-240
24 cm



04-185-195
19.5 cm



04-186-215
21.5 cm

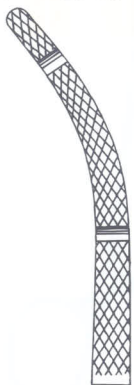

04-187-240
24 cm

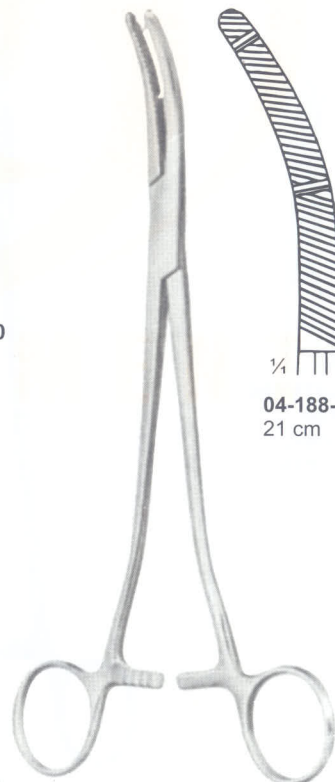

HEANEY-
KANTER



04-188-210
21 cm

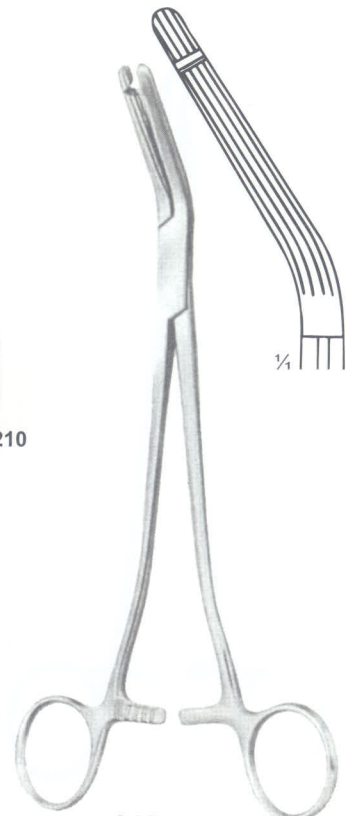

GARLAND
04-189-210
21.0 cm

HAEMOSTATIC FORCEPS



GUYON

GUYON

GUYON

NEGUS

FINOCCHIETTO

STILLE

HAEMOSTATIC FORCEPS



04-200-210
21 cm

DESJARDINS



04-201-200
20 cm

JOHN HOPKINS



04-202-200
20 cm
Slightly
Curved

FAURE 1:2

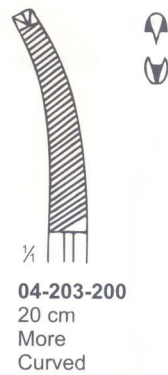

04-203-200
20 cm
More
Curved

HAEMOSTATIC FORCEPS



ROCHESTER / OCHSNER / KOCHER

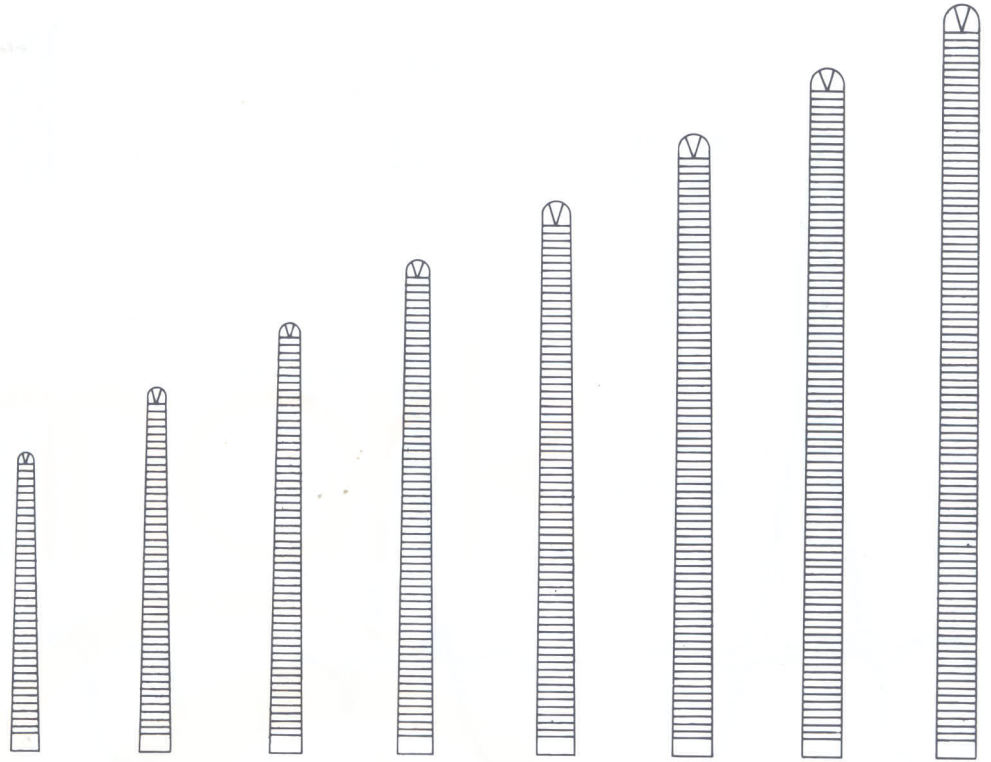

- | | | | | | | | |
|--|--|--|--|--|--|--|--|
| 04-204-140
14 cm
straight,
1:2 Teeth | 04-205-160
16 cm
straight,
1:2 Teeth | 04-206-180
18 cm
straight,
1:2 Teeth | 04-207-200
20 cm
straight,
1:2 Teeth | 04-208-220
22 cm
straight,
1:2 Teeth | 04-209-240
24 cm
straight,
1:2 Teeth | 04-210-260
26 cm
straight,
1:2 Teeth
serrated | 04-211-300
30 cm
straight,
1:2 Teeth
serrated |
|--|--|--|--|--|--|--|--|

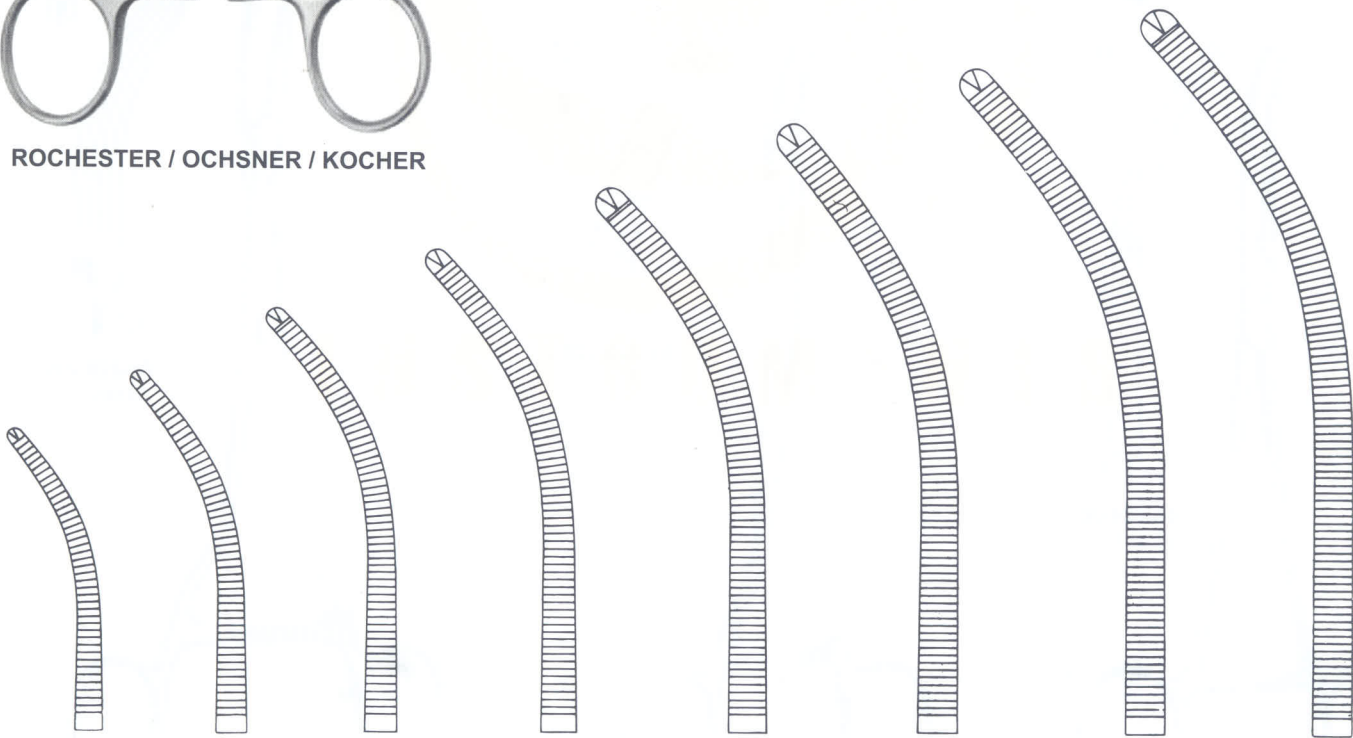

- | | | | | | | | |
|--|--|--|--|--|--|--|--|
| 04-212-140
14 cm
Curved,
1:2 Teeth | 04-213-160
16 cm
Curved,
1:2 Teeth | 04-214-180
18 cm
Curved,
1:2 Teeth | 04-215-200
20 cm
Curved,
1:2 Teeth | 04-216-220
22 cm
Curved,
1:2 Teeth | 04-217-240
24 cm
Curved,
1:2 Teeth | 04-218-260
26 cm
Curved,
1:2 Teeth | 04-219-300
30 cm
Curved,
1:2 Teeth |
|--|--|--|--|--|--|--|--|

HAEMOSTATIC FORCEPS

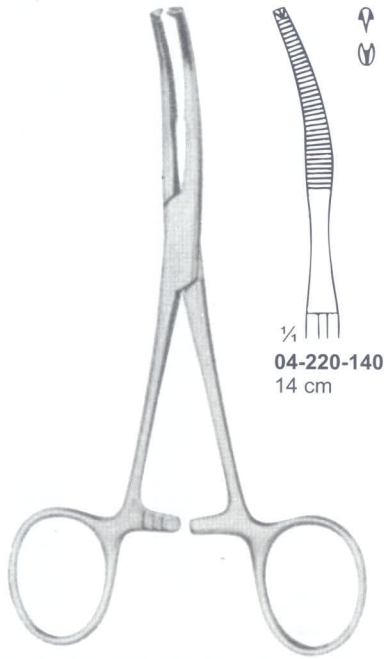

¼
04-220-140
14 cm

BABY-MIKULICZ 1:2

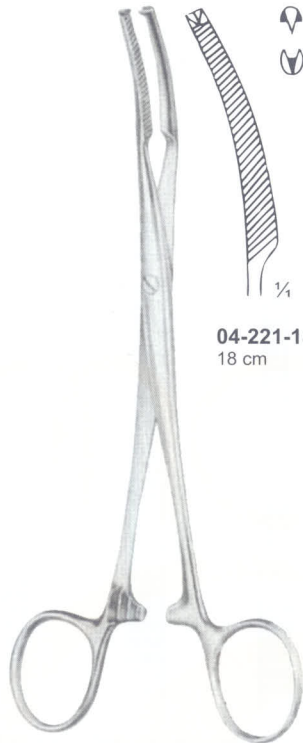

¼
04-221-180
18 cm

MIKULICZ 1:2



¼
04-222-200
20 cm

MIKULICZ 1:2



¼
04-223-200
20 cm

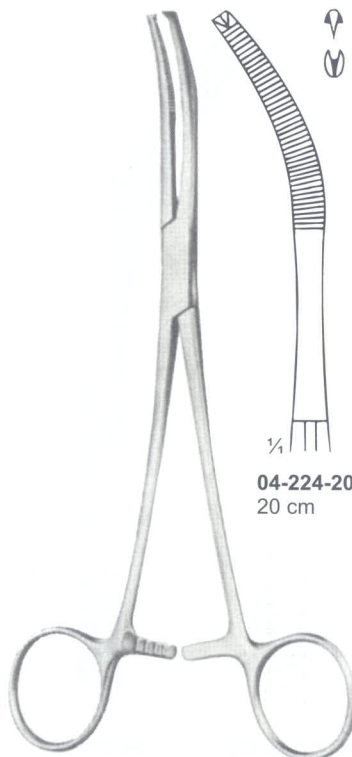

¼
04-224-200
20 cm

MIKULICZ 1:2



¼
04-225-200
20 cm

MIKULICZ 1:2

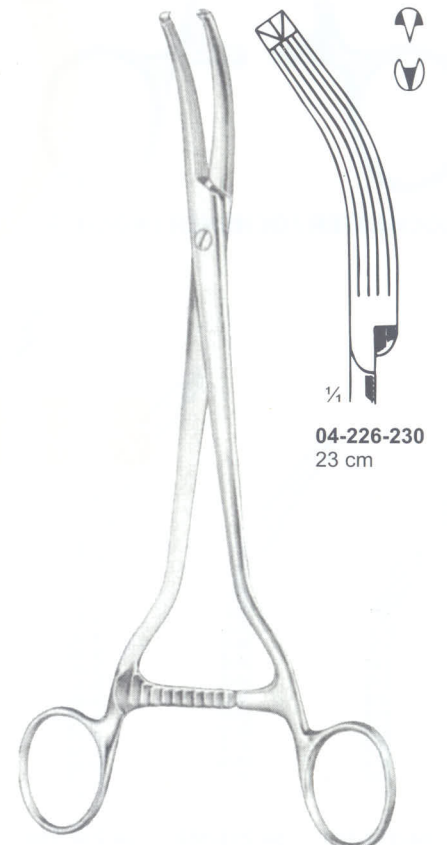

¼
04-226-230
23 cm

MIKULICZ 1:2

HAEMOSTATIC FORCEPS

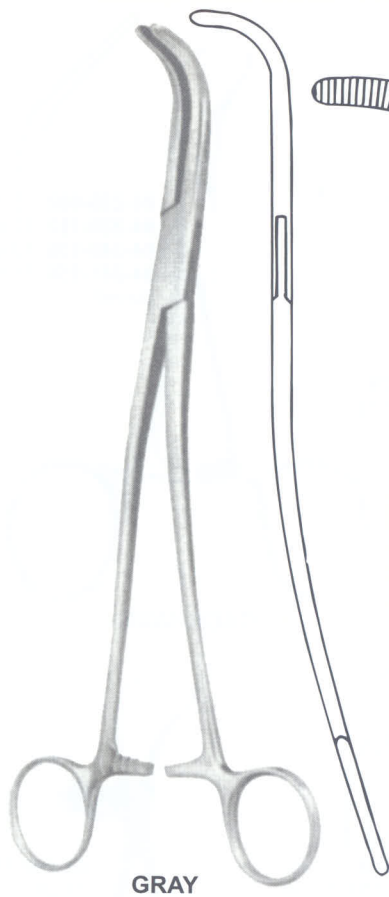

GRAY

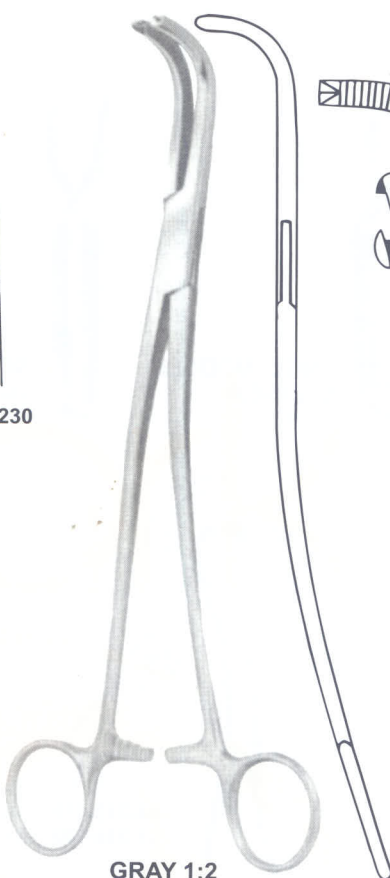
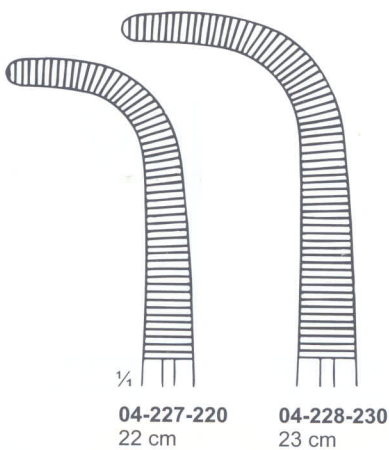

GRAY 1:2

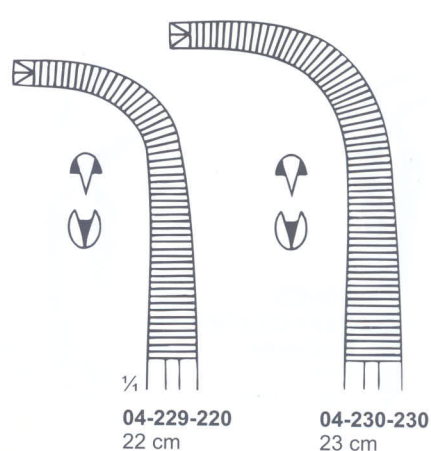

PHANEUF 1:2

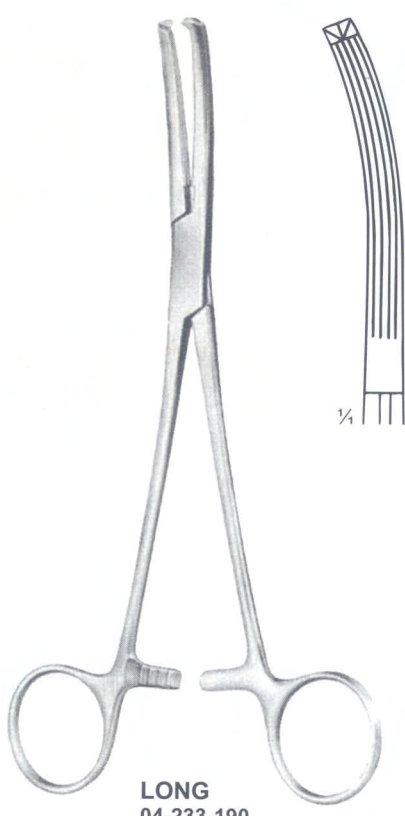
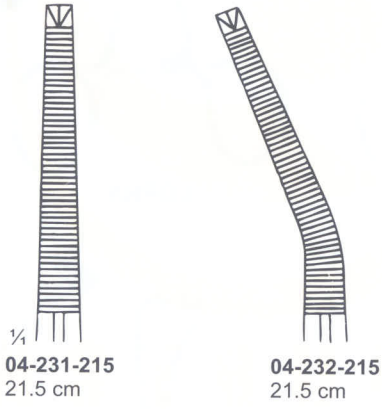

LONG
04-233-190
19.0 cm



TOWEL FORCEPS



JONES / PERFORATING
04-234-090
9 cm
Slight Curve



ENGL. MODELL
04-235-090
9 cm



SCHAEFFEL
04-236-090
9 cm



DOYEN
04-237-180
18 cm

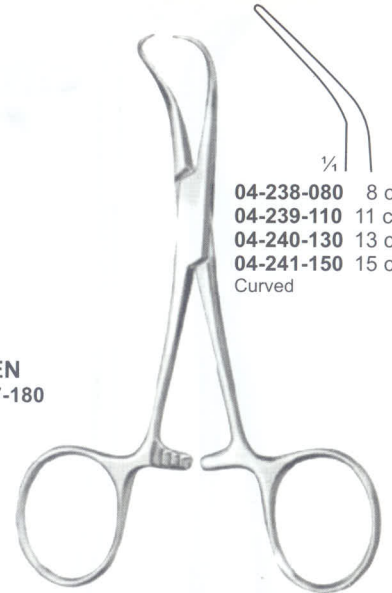

04-238-080 8 cm
04-239-110 11 cm
04-240-130 13 cm
04-241-150 15 cm
Curved

BACKHAUS



04-242-130
13 cm
Curved,
Serrated

ROEDER

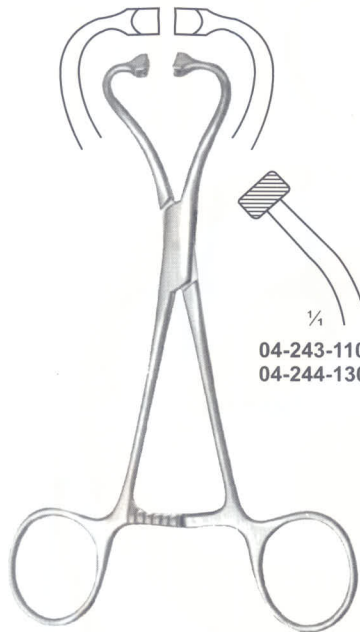

04-243-110 11 cm
04-244-130 13 cm

NON-PERFORATING

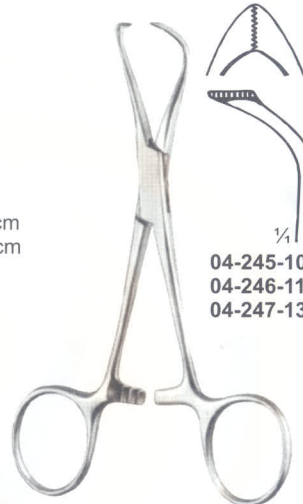

04-245-100 10 cm
04-246-110 11 cm
04-247-130 13 cm

LORNA

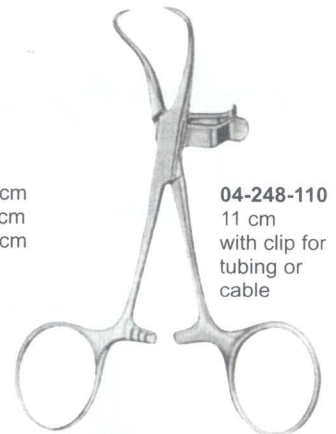

04-248-110
11 cm
with clip for
tubing or
cable

BACKHAUS CLIP



04-249-130
13 cm
Non-
perforating

BALL & SOCKET

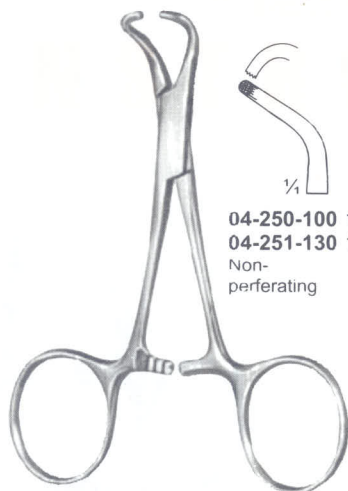

04-250-100 10cm
04-251-130 13cm
Non-
perforating

TOHOKU



04-252-130
13.25 cm
Serrated

PEERS-BERTMAN

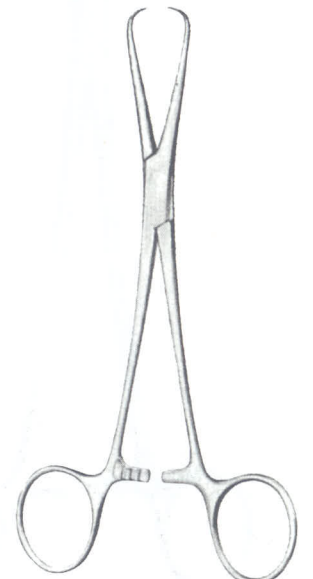

BERNHARD
04-253-165
16.5 cm

HAEMOSTATIC FORCEPS

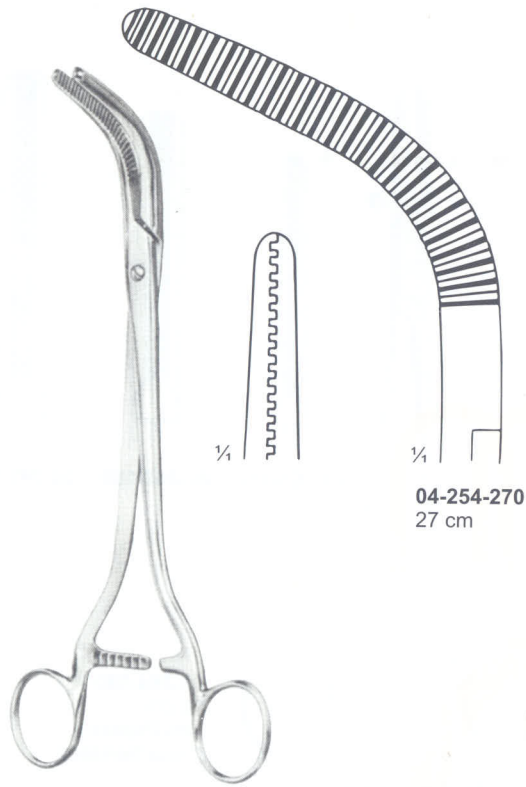

04-254-270
27 cm

WERTHEIM

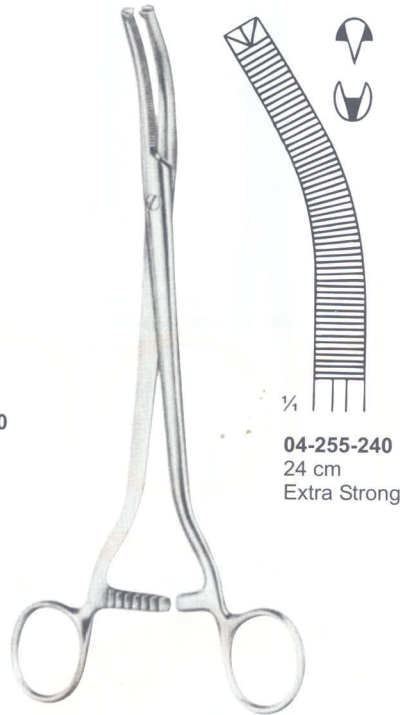

04-255-240
24 cm
Extra Strong

WERTHEIM 1:2

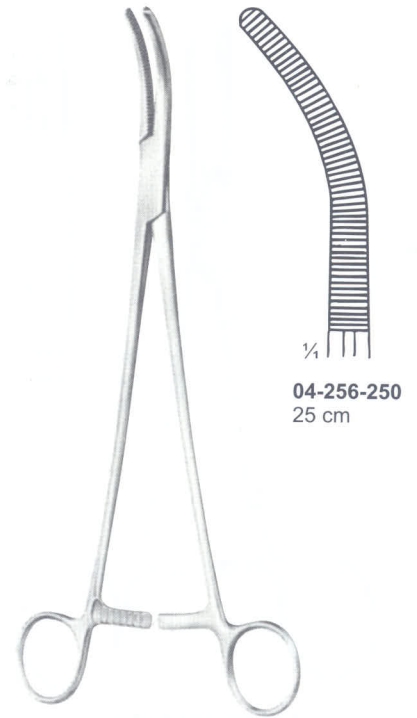

04-256-250
25 cm

WERTHEIM



04-257-230
23 cm
slightly curved

WERTHEIM 1:2



04-258-230
23 cm
more curved



04-259-215
21.5 cm

WERTHEIM-CULLEN