



plane (nylon)
convex (steel)
plastic handle
Head 30mm Ø
Weight 675 Gr.

1/3

MALLET
09-196-265
26.5 cm



plastic handle
Head 42 / 30mm Ø
Weight 530 Gr.

1/3

MALLET
09-197-260
26 cm



plastic handle
Head 30mm Ø
Weight 480 Gr.

1/3

MALLET
09-198-240
24 cm



Plastic Handle
Head 30mm Ø
Weight 510 Gr.

1/3

MALLET
09-199-260
26 cm



Spare Facing (pair)
09-201-00
Plastic

disks and plastic handle
Head 37mm Ø
Weight 370 Gr.

1/3

MALLET
09-200-240
24 cm



made of plastic
Head 30mm Ø
Weight 125 Gr.

1/3

MALLET
09-202-220
22 cm

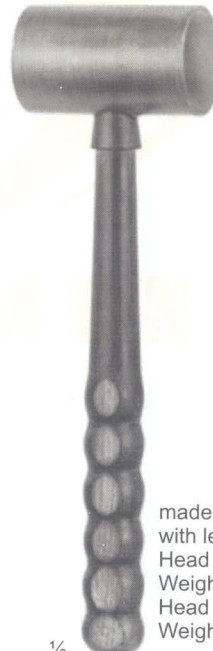

made of plastic
with lead filling
Head 42mm Ø
Weight 400 Gr.
Head 42mm Ø
Weight 250 Gr.

1/3

MALLET
09-203-260
26 cm

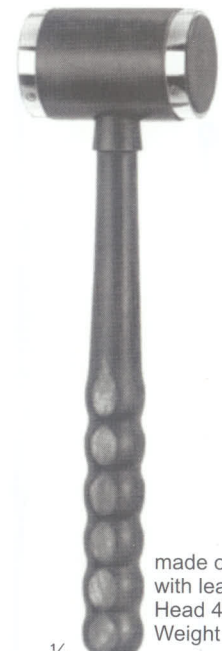

made of plastic
with lead filling
Head 42mm Ø
Weight 400 Gr.

1/3

MALLET
09-204-260
26 cm

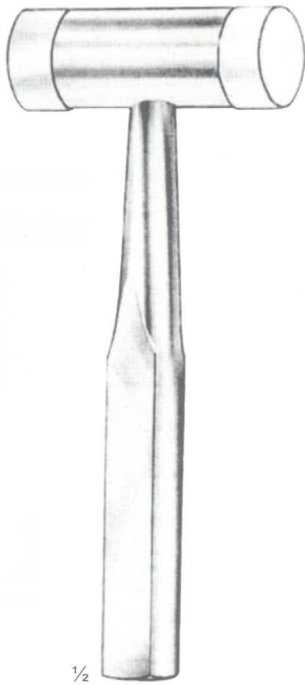

1/2
ORTHO / WITH PLASTIC CAPS
09-205-180
18 cm
25 mm Dia.
5OZ (140g)



1/3
HAJEK
09-206-223
22.25 cm
27 mm Dia.
5OZ (140g)

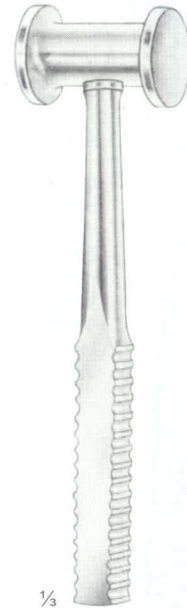

1/4
BERGMANN
09-207-240
24 cm
10 1/4OZ (300g)



1/2
COTTLE
09-208-190
19 cm
8 1/2OZ (240g)



1/3
COLLIN
09-209-230
23 cm
33 mm Dia.
7 3/4OZ (220g)



1/4
09-211-155
Head 26 mm Ø
Weight 300 Gr.
09-212-155
Head 28 mm Ø
Weight 340 Gr.
09-213-155
Head 30 mm Ø
Weight 400 Gr.
WILLIGER
09-210-155
15.5 cm



09-215-205
Head 25 mm Ø
Weight 120 Gr.
09-216-205
Head 30 mm Ø
Weight 180 Gr.
09-217-205
Head 35 mm Ø
Weight 260 Gr.

1/2

DOYEN
09-214-205
20.5 cm

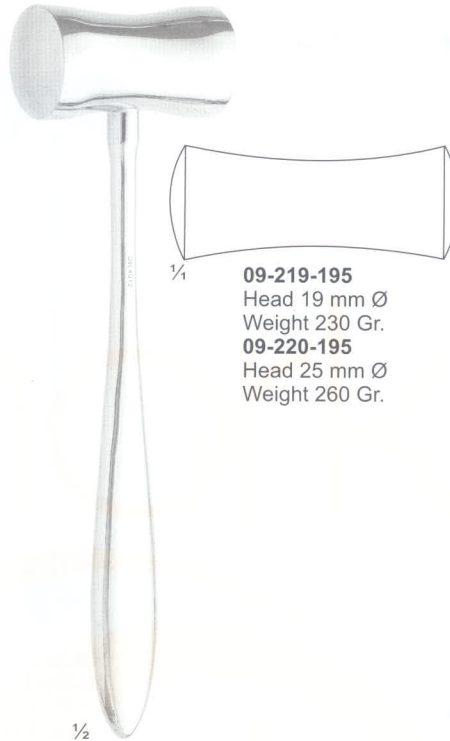

09-219-195
Head 19 mm Ø
Weight 230 Gr.
09-220-195
Head 25 mm Ø
Weight 260 Gr.

1/2

LUCAE
09-218-195
19.5 cm



1/2

WILLIGER
09-221-165
16.5 cm
Head 20 mm Ø
weight 140 Gr.

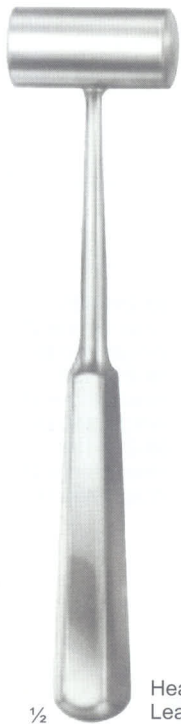

1/2

PARTSCH
09-222-190
19 cm

Head 22mm Ø
Lead Filled



1/2

MEAD
09-223-190
19 cm

09-224-190
with interchangeable
Plastic dicks
Head 27 mm Ø
Weight 320 Gr.

Spare Facings
09-225-190

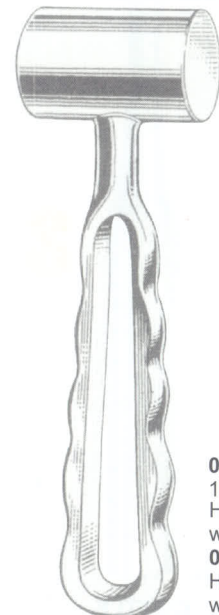

HEATH

09-226-160
16 cm
Head 3.5 cm Ø
weight 510.27 Gr.
09-227-165
Head 4.5 cm Ø
weight 793 Gr.