

Nasenspekula
 Nasal Specula
 Spéculum nasal
 Espéculos nasales
 Specoli nasali

PROFIT[®]
 Surgical Instruments

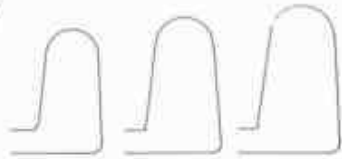

46.050.01 Fig. 1 46.050.02 Fig. 2 46.050.03 Fig. 3 46.050.04 Fig. 4



46.050.05 Fig. 5 46.050.06 Fig. 6 46.050.07 Fig. 7

THUDICHUM
 46.050.01-46.050.07



46.060.01
 Fig. 1



46.060.02
 Fig. 2



46.060.03
 Fig. 3



VOLTOLINI
 46.060.01-46.060.03

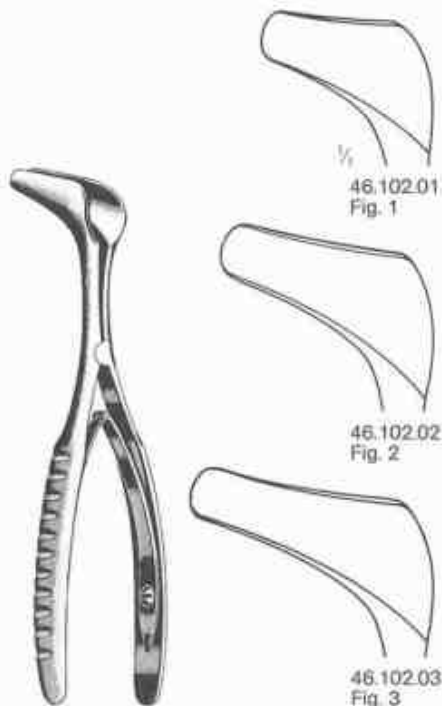

HARTMANN-HALLE
 46.102.01-46.102.03
 15 cm



Mod. Wien · Vienna ·
 Vienne · Viena

Baby · Bèbé	46.112.01
Kind · child · enf. · niño · bamb.	46.112.02
Erw. · Adult.	46.112.03



Mod. Wien · Vienna
 Vienne · Viena
 46.113.03
 leichtes Modell
 lightweight
 mod. léger
 mod. ligero
 mod. leggero

Nasenspekula
 Nasal Specula
 Spéculums nasaux
 Espéculos nasales
 Specoli nasali

PROFIT[®]
 Surgical Instruments



TIECK-HALLE
 46.116.13
 13,5 cm



KILLIAN
 46.120.35-46.120.90
 13 cm

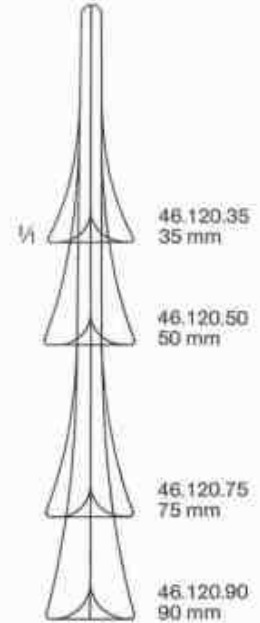

COTTLE
 46.124.35-46.124.90
 14 cm



COTTLE
 46.126.35-46.126.90
 schwarz · black · noirs
 negros · neri
 14 cm

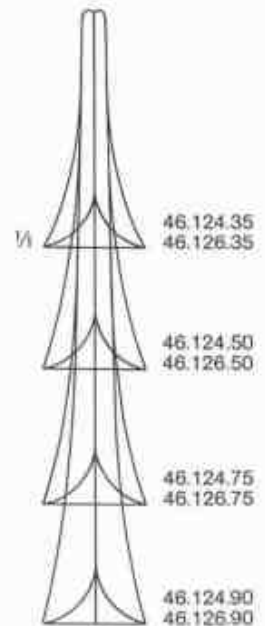

Rhinologie
 Rhinology
 Rhinologie
 Rinología
 Rinologia



YANKAUER
 46.131.19
 19 cm



MICHEL
 46.139.12-46.139.18
 25 cm

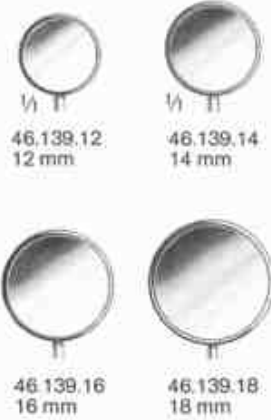

TROELTSCH **TROELTSCH**
 48.151.15 46.151.18
 15 cm 18 cm



JÄNSEN
 46.154.20
 20 cm

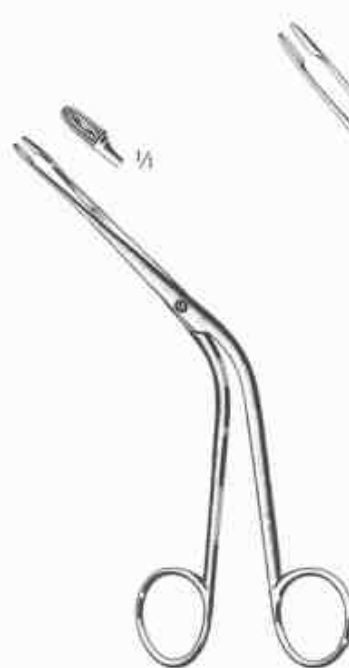

HARTMANN
 46.161.16
 16 cm



HARTMANN
 46.161.20
 20 cm

Rhinologie
 Rhinology
 Rhinologie
 Rinologia
 Rinologia

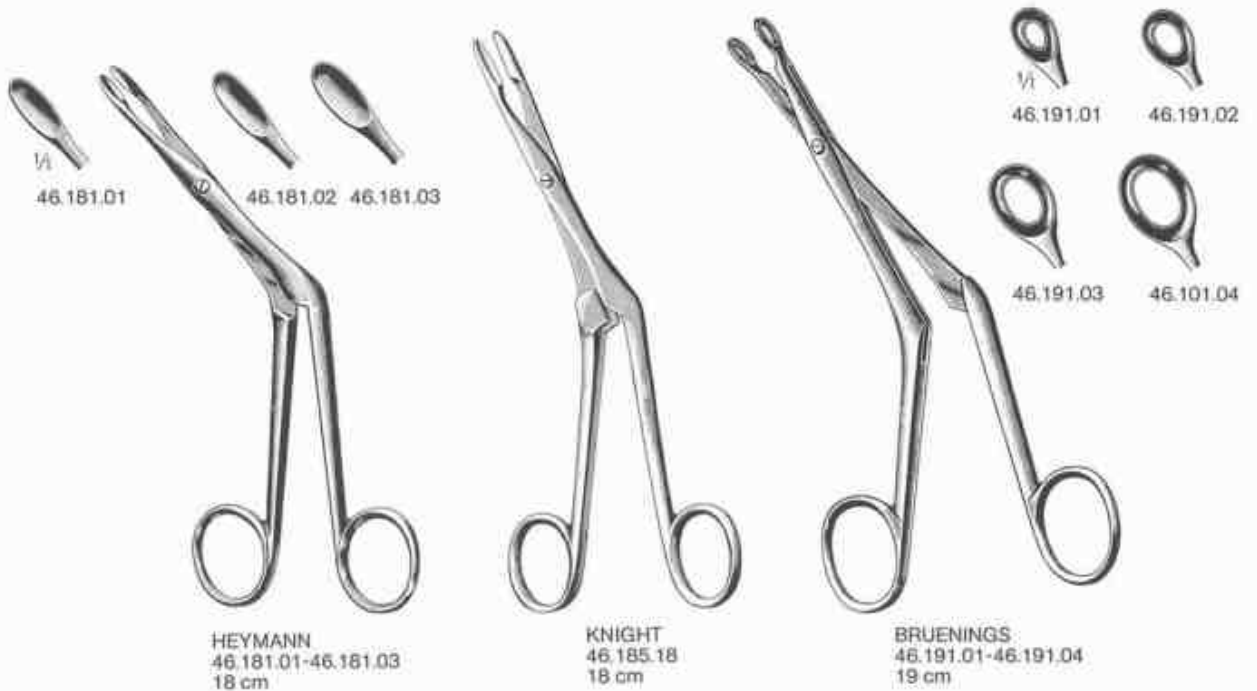
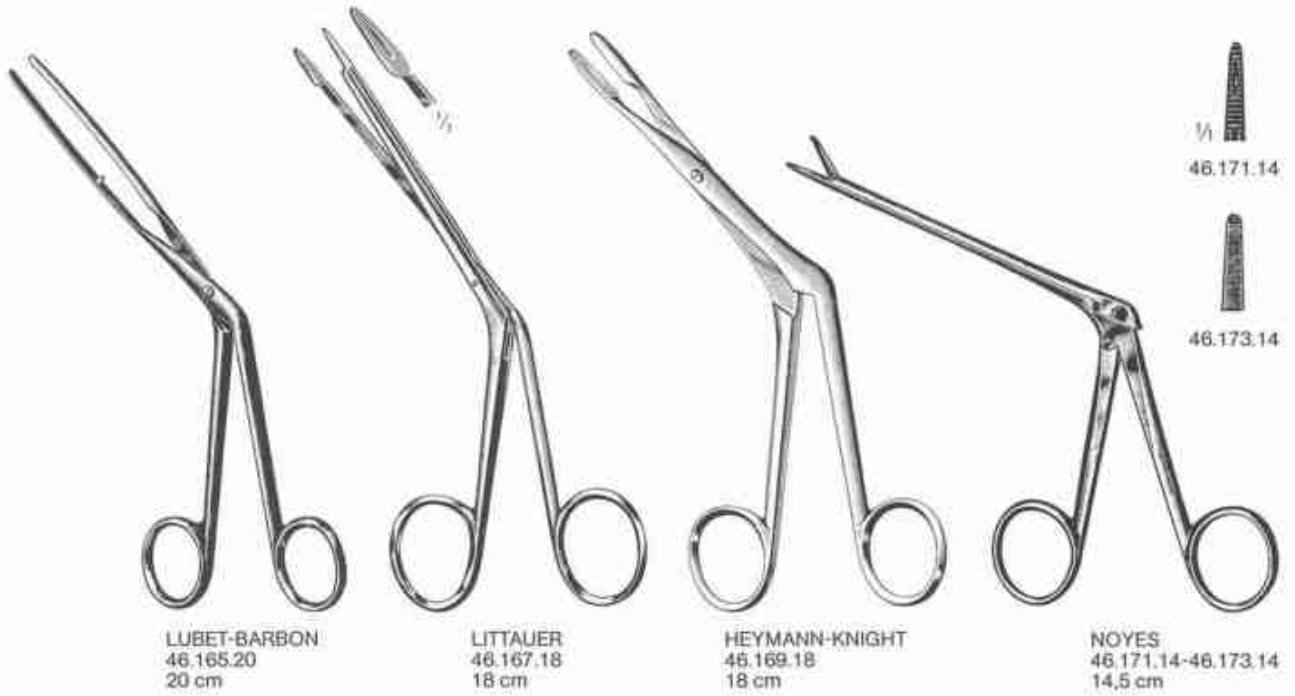

Scharfe Nasenzangen
 Nasal Cutting Forceps
 Pincas coupantes nasales
 Pinzas cortantes nasales
 Pinze taglienti nasali

PROFIT[®]
 Surgical Instruments



LUC
 46.195.01-46.195.02
 19 cm

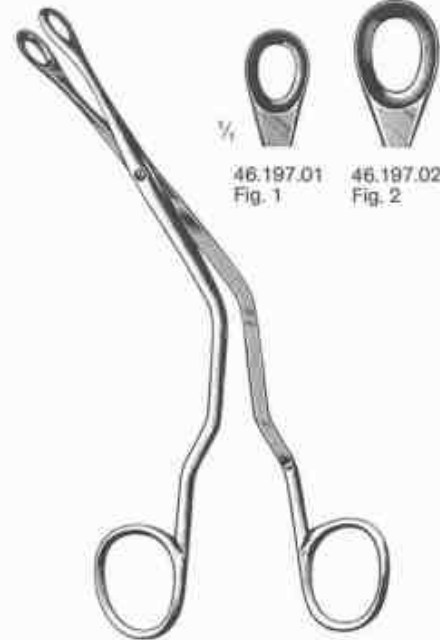

LUC
 46.197.01-46.197.02
 19 cm



ohne Hals
 without neck
 sans cou
 sin cuello
 senza collo



46.221.01
 Fig. 1

46.221.02
 Fig. 2

46.221.03
 Fig. 3

46.221.04
 Fig. 4

46.221.05
 Fig. 5

mit Hals
 with neck
 avec cou
 con cuello
 con collo



46.223.01
 Fig. 1

46.223.02
 Fig. 2

46.223.03
 Fig. 3

46.223.04
 Fig. 4

46.223.05
 Fig. 5

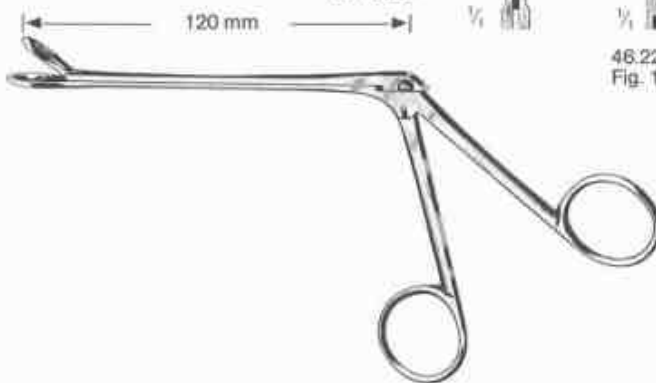

WEIL-BLAKESLEY
 46.221.01-46.223.05

Rhinologie
 Rhinology
 Rhinologie
 Rinología
 Rinologia

Scharfe Nasenzangen
 Nasal Cutting Forceps
 Pincas coupantes nasales
 Pinzas cortantes nasales
 Pinze taglianti nasali



46.231.01-46.237.03
 19 cm



STRUYCKEN
 46.231.01
 Fig. 1



STRUYCKEN
 46.231.02
 Fig. 2

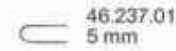

46.237.01
 5 mm



46.237.02
 7 mm

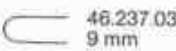

46.237.03
 9 mm



MYLES

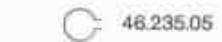

46.235.05



46.235.07



46.235.09



46.235.11



HARTMANN



Septum-Quetschzange
 Septum Crushing Forceps
 Pince à écraser la cloison
 Pinza para magullar tabique
 Pinza per ammaccare il setto

RUBIN
 46.251.21
 21 cm

Rhinologie
 Rhinology
 Rhinologie
 Rinologia
 Rinologia

PROFIT[®]
 Surgical Instruments



mm x mm	KERRISON
3 x 3	46.303.03
4 x 4	46.303.04
5 x 5	46.303.05
6 x 6	46.303.06
17 cm	

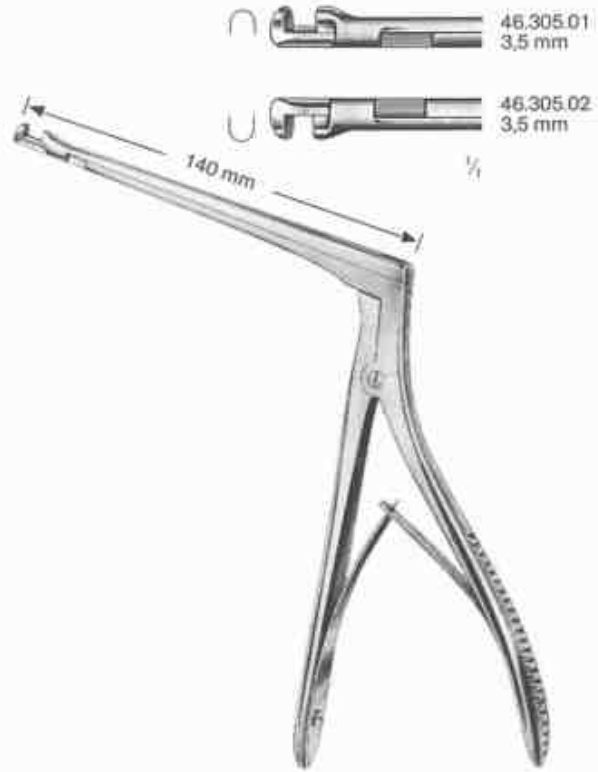

HAJEK-KOFLER
 46.305.01-46.305.02



mm	CITELLI
1,0	46.311.10
2,5	46.311.25
4,0	46.311.40



BEYER
 46.315.20
 2.0 mm



HAJEK-CLAUS
 46.320.20
 20 cm

Rhinologie
 Rhinology
 Rhinologie
 Rinología
 Rinologia



MIDDLETON-JANSEN
 46.323.19
 19 cm



MIDDLETON-JANSEN
 46.325.19
 19 cm



Ø mm	LICHTWITZ
1,5	46.340.15
1,8	46.340.18
2,0	46.340.20

Luer-Lock
 10 cm



KILLIAN
 46.341.03
 14 cm/3 mm Ø



KRAUSE
 46.351.26
 26 cm



WILDE
 46.352.24
 24 cm



46.355.03
 0,3 mm

Nasenmesser
 Nasal Knives
 Bistouris nasaux
 Bisturías nasales
 Coltelli nasali

PROFIT[®]
 Surgical Instruments



JOSEPH
 46.370.16-46.373.16



46.370.16
 stumpf · blunt · mousses
 romos · amussi



46.371.16



46.372.16
 spitz · pointed · pointus
 puntiagudos · acuti



46.373.16



FREER
 46.374.15
 15 cm



FREER
 46.375.19
 19 cm



JOSEPH
 46.376.16
 16 cm



CONVERSE
 46.379.16
 16 cm



COTTLE
 46.380.15
 15 cm



46.382.15



COTTLE
 46.384.15



46.385.15

Septum-Messer
 Septum Knives
 Couteaux pour la cloison
 Cuchillos para tabique
 Coltelli per setto

PROFIT[®]
 Surgical Instruments

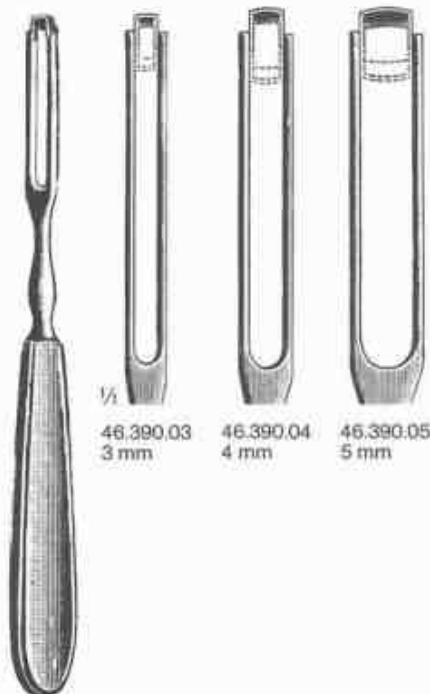

1/2
 46.390.03 3 mm
 46.390.04 4 mm
 46.390.05 5 mm

BALLENGER
 46.390.03-46.392.05
 20 cm

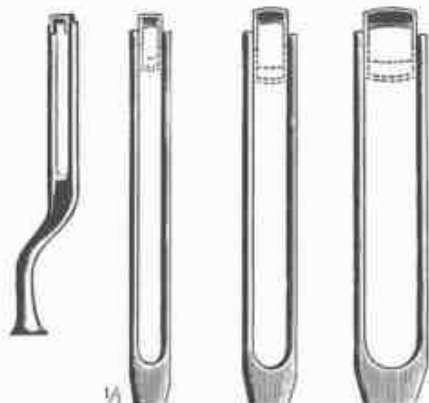

1/2
 46.392.03 3 mm
 46.392.04 4 mm
 46.392.05 5 mm



BRUENINGS
 46.398.16
 16,5 cm

Septum-Elevatoren
 Septum Elevators
 Élévateurs pour la cloison nasale
 Elevadores para tabique
 Elevatori per setto

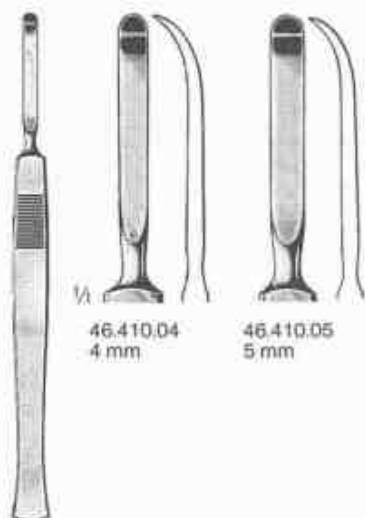

1/2
 46.410.04 4 mm
 46.410.05 5 mm

McKENY
 46.410.04-46.410.05
 15 cm



ROGER
 46.413.19
 19 cm



FREER
 46.415.18
 18 cm



FREER
 46.417.19
 19 cm



FREER
 46.419.19
 19 cm

Rhinologie
 Rhinology
 Rhinologie
 Rinologia
 Rinologia



COTTLE
 46.421.23
 23 cm



COTTLE
 46.423.22
 22 cm



JOSEPH
 46.425.16
 16 cm



COTTLE
 46.425.19
 19 cm



KILLIAN
 46.428.22
 22 cm



HAJEK-BALLENGER
 46.428.21
 22 cm



BALLENGER
 46.430.22
 22 cm



FREER
 46.450.04
 4 mm



FREER
 46.451.04
 4 mm

Nasenplastik-Meißel
 Rhinoplastic Chisels
 Ciseaux-burins pour la plastique nasale
 Cinceles para la plástica nasal
 Scalpelli per plastica nasale

PROFIT[®]
 Surgical Instruments

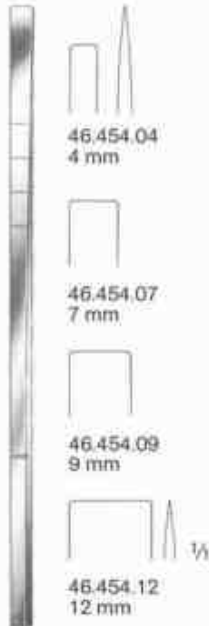

COTTLE
 46.454.04-46.454.12
 18 cm



COTTLE
 46.455.06
 18 cm/6 mm

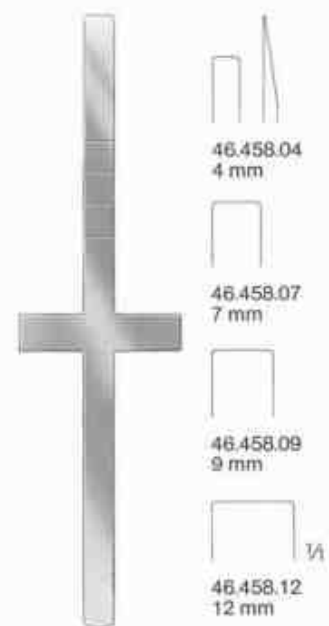

COTTLE
 46.458.04-46.458.12

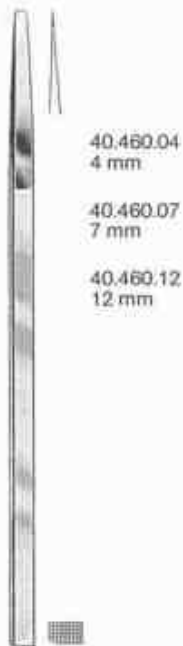

COTTLE
 40.460.04-40.460.12
 18 cm

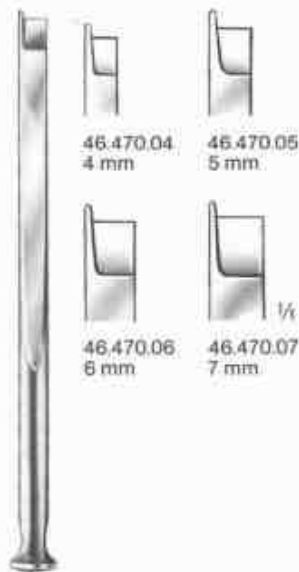

FOMON
 46.470.04-46.470.07
 17 cm

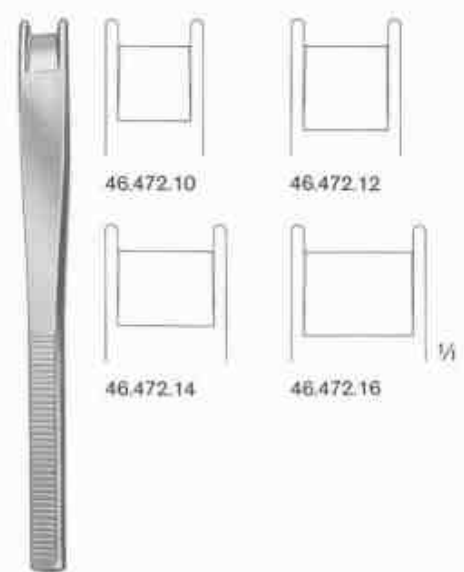

CINELLI
 46.472.10-46.472.16

Rhinologie
 Rhinology
 Rhinologie
 Rinologia
 Rinologia

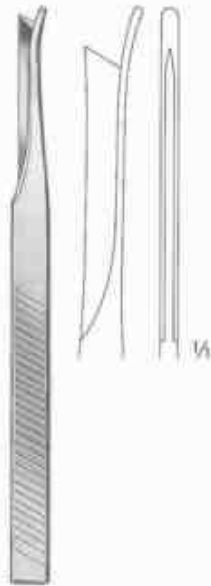

SILVER
 46.473.01
 18 cm

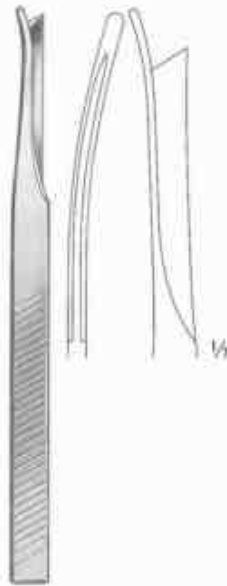

SILVER
 46.473.02
 18 cm

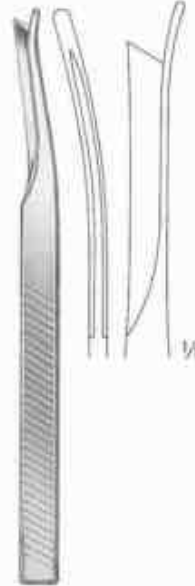

SILVER
 46.473.03
 18 cm



KILLIAN-CLAUS
 46.482.05
 17 cm/5 mm



mm	HAJEK
4	46.484.04
6	46.484.06
8	46.484.08



WEST
 46.486.16
 16 cm



WEST
 46.487.16
 16 cm



FREER
 46.489.16
 6 mm



JOSEPH
 46.502.16
 16 cm

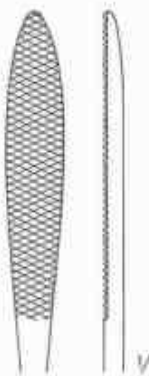

AUFRICHT
 46.504.18
 18 cm

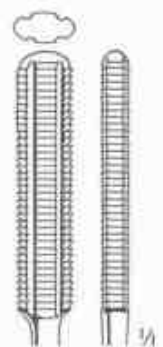

Rhinologie
 Rhinology
 Rhinologie
 Rinología
 Rinologia



WIENER
 46.507.18-48.507.19
 18 cm



46.507.18



48.507.19



WIENER (AUFRICHT)
 46.511.21-46.513.21
 21 cm



46.511.21



46.513.21



JOSEPH (LEWIS)
 46.514.16-46.516.16
 18 cm



46.514.16
 fein - fine
 fina



46.516.16
 grob - coarse - gruesa
 dentellure grosse
 dentellatura grossa



MALTZ (COTTLE)
 46.518.21
 21 cm



1/2



FOMON
 46.520.21
 21 cm



1/2



1/2



Rhinologie
 Rhinology
 Rhinologie
 Rinologia
 Rinologia

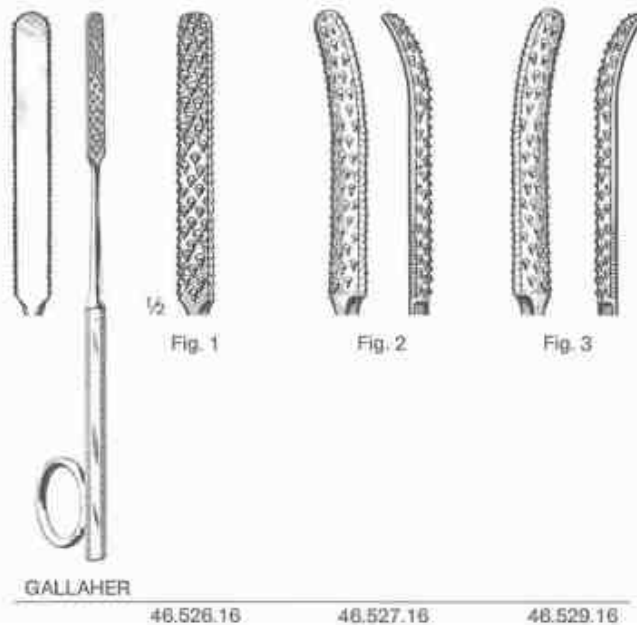
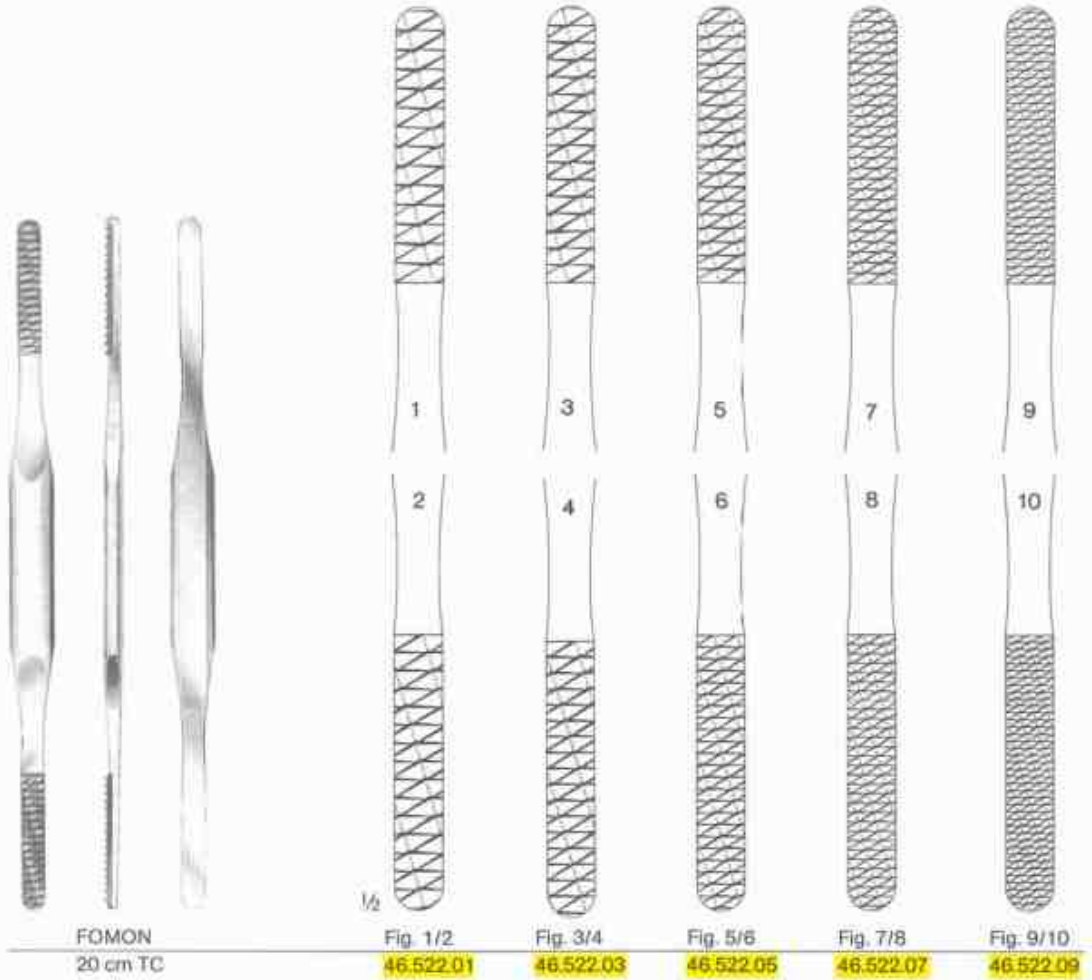

Rhinologie
 Rhinology
 Rhinologie
 Rinología
 Rinologia



JOSEPH

19 cm	46.532.19	46.534.19
	links - left	rechts - right
	à gauche	à droite
	izquierda	derecha
	a sinistra	a destra

JOSEPH
 46.535.01 17 cm 46.535.02

AUFRICHT
 46.551.16
 19 cm

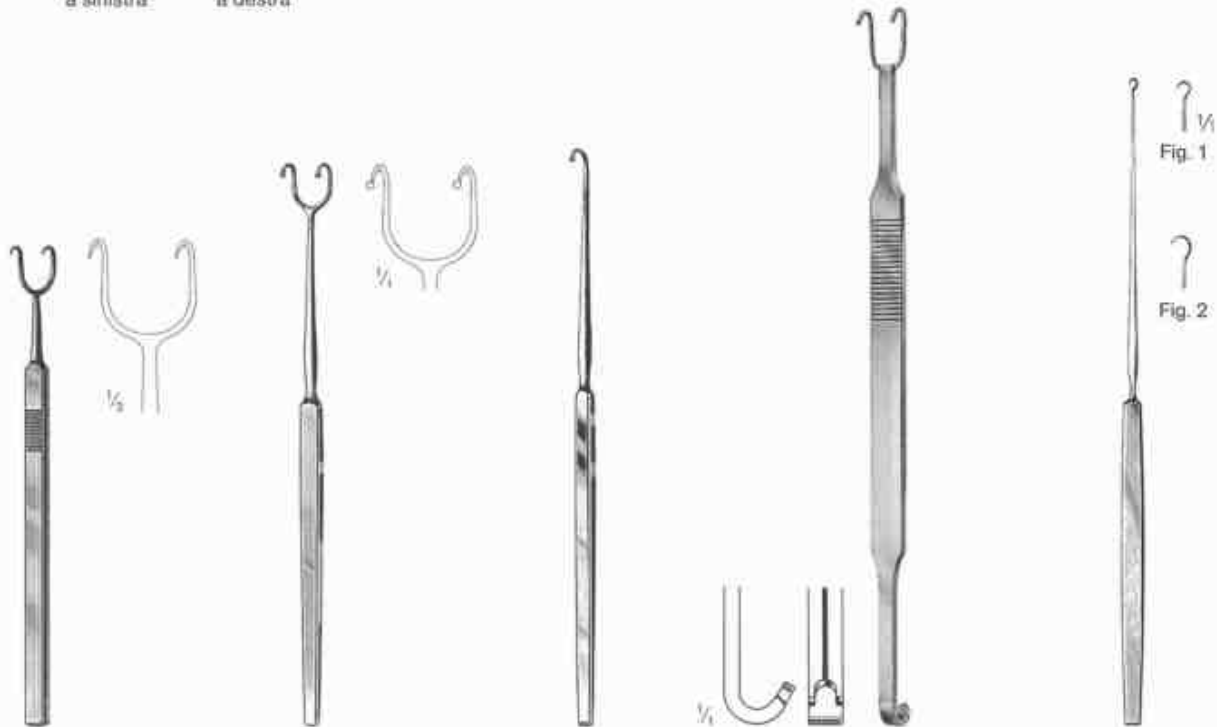

COTTLE
 46.556.14

FOMON
 46.556.15

FOMON
 46.557.17

COTTLE-NEIVERT
 46.559.20

Fig.	GILLIES
1	46.560.18
2	46.562.18
	18 cm

Rhinologie
 Rhinology
 Rhinologie
 Rinologia
 Rinologia



ASCH
 46.571.23
 23 cm

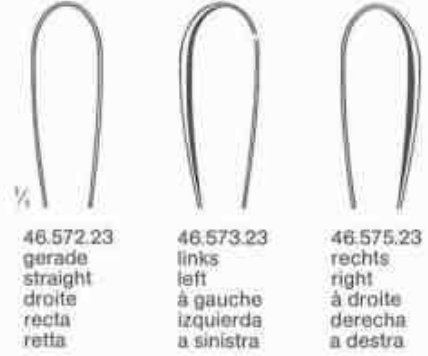

46.572.23
 gerade
 straight
 droite
 recta
 retta

46.573.23
 links
 left
 à gauche
 a sinistra

46.575.23
 rechts
 right
 à droite
 a destra

WALSHAM
 46.572.23-46.575.23
 23 cm



JATHO
 46.595.15



FAULKNER
 46.601.21
 21 cm

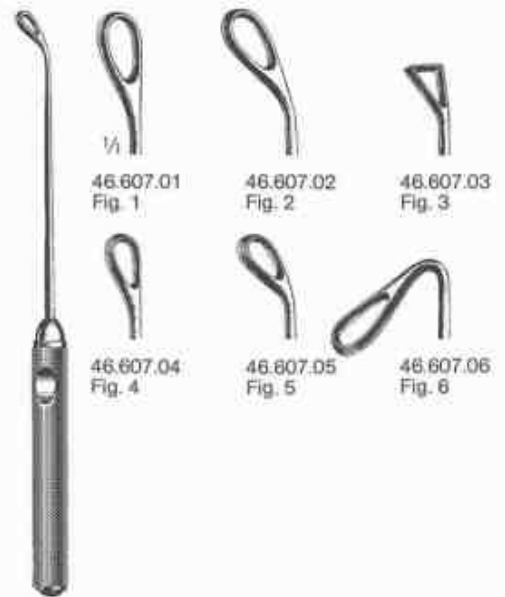

46.607.01
 Fig. 1

46.607.02
 Fig. 2

46.607.03
 Fig. 3

46.607.04
 Fig. 4

46.607.05
 Fig. 5

46.607.06
 Fig. 6

COAKLEY
 46.607.01-46.607.06
 17 cm



BECKMANN
 46.620.01-46.620.06
 22 cm

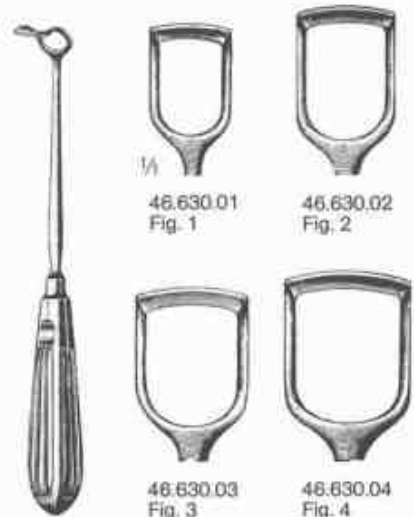

BARNHILL
 46.630.01-46.630.04
 21 cm

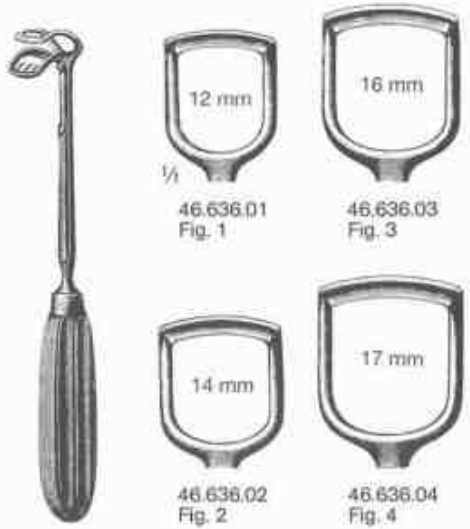

St. CLAIR-THOMSON
 46.636.01-46.636.04
 21 cm

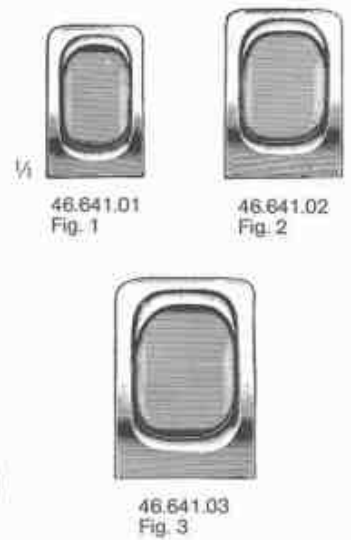

Ersatzklingen, gelocht
 Spare blades, perforated
 Lames de rechange, perforées
 Hojas de repuesto, perforadas
 Lame di ricambio, forate

Fig.	
1	46.642.01
2	46.642.02
3	46.642.03



LAFORCE
 46.641.01-46.641.03
 25 cm