

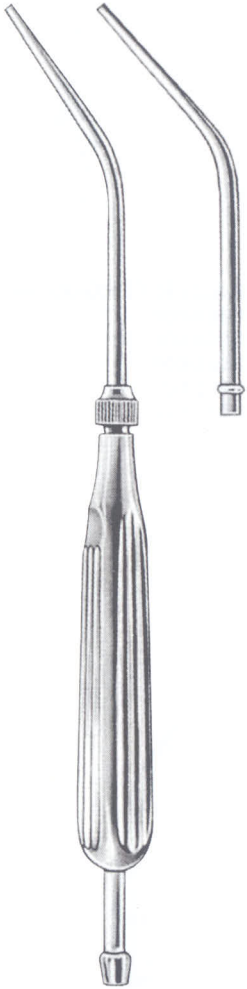

SUCTION TUBES

1.5 mm 2.0 mm



COUPLAND
01-067-000



BYRD
01-068-000 1.5 mm
01-069-000 2.5 mm
01-070-000 3.5 mm

8.0 mm

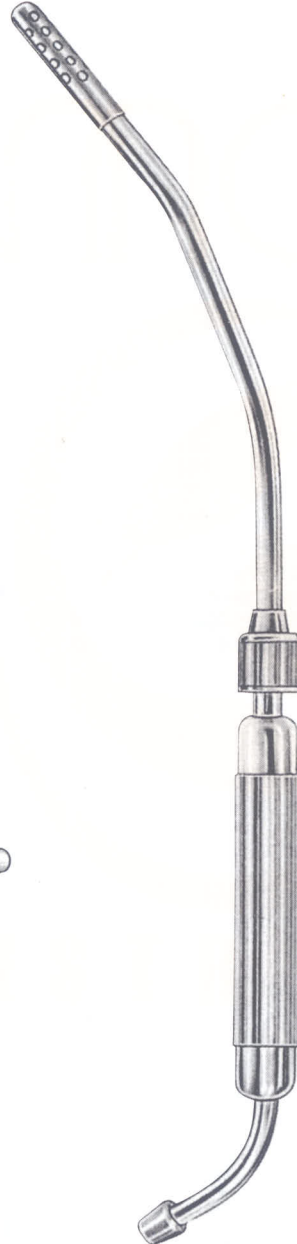

COOLEY
01-071-330
33.0 cm

8.0 mm



COOLEY
01-072-350
35 cm

6.0 mm

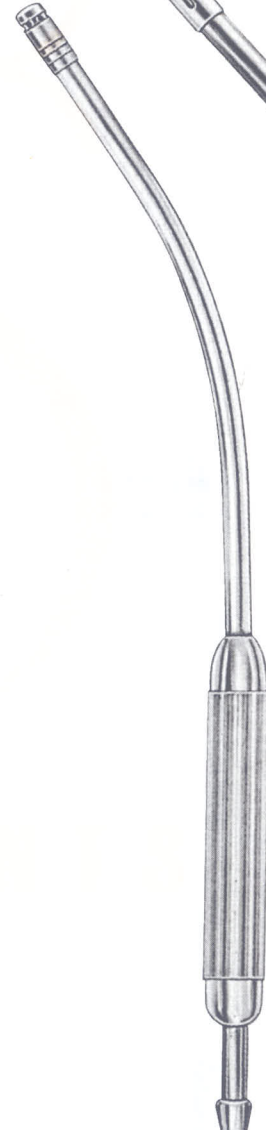

COOLEY
01-073-300
30.0 cm

10.0 mm

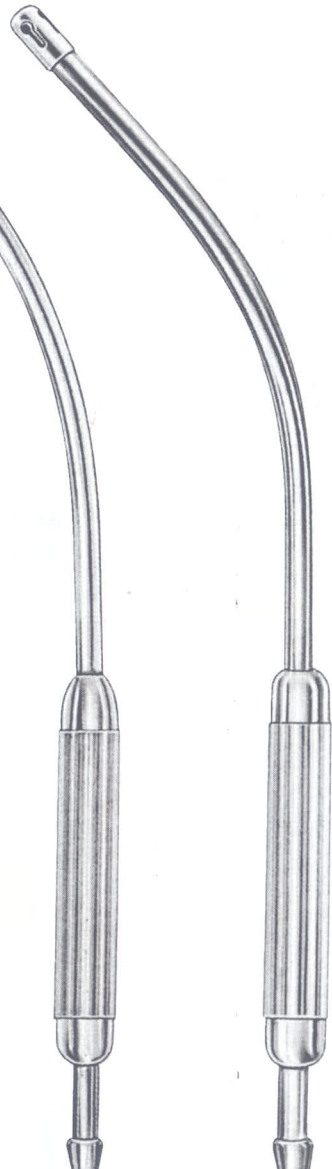

COOLEY
01-074-310
31.0 cm

SUCTION TUBES



ADSON
01-075-150
4 mm Ø 15 cm



ADSON
01-076-150 4 mm Ø 15 cm
01-077-200 4 mm Ø 20 cm
01-078-200 5 mm Ø 20 cm



PLESTER
01-079-000 1.5 mm Ø
01-080-000 2.0 mm Ø
01-081-000 2.5 mm Ø
01-082-000 3.0 mm Ø



FRAZIER-FERGUSON
01-083-000 6 Fr.
01-084-000 7 Fr.
01-085-000 9 Fr.
01-086-000 10 Fr.
01-087-000 11 Fr.
11.4 cm

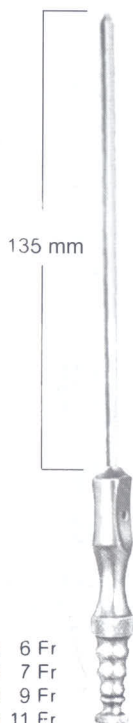

FRAZIER
19 cm
01-088-000 6 Fr
01-089-000 7 Fr
01-090-000 9 Fr
01-091-000 11 Fr



FRAZIER 30°
18 cm
01-092-000 6 Fr.
01-093-000 7 Fr.
01-094-000 8 Fr.
01-095-000 9 Fr.
01-096-000 10 Fr.
01-097-000 11 Fr.
01-098-000 12 Fr.
01-099-000 15 Fr

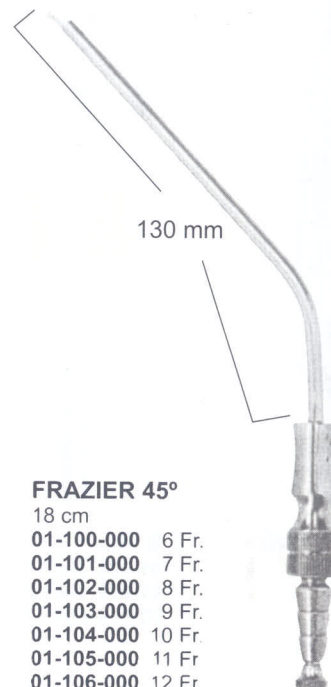

FRAZIER 45°
18 cm
01-100-000 6 Fr.
01-101-000 7 Fr.
01-102-000 8 Fr.
01-103-000 9 Fr.
01-104-000 10 Fr.
01-105-000 11 Fr.
01-106-000 12 Fr



SUCTION TUBES / TROCARS

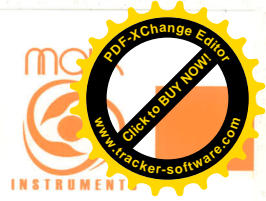

YANKAUER
01-107-270
27 cm

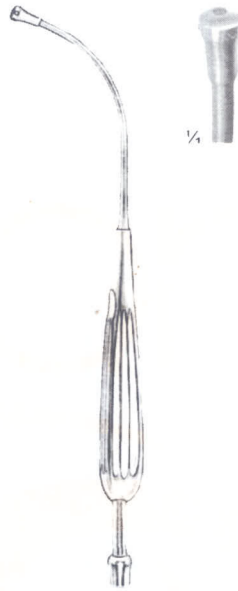

ANDREWS-PYNCHON
01-108-235
23.5 cm

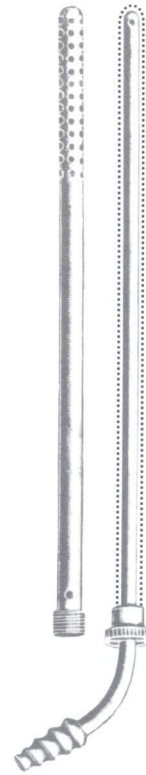

POOLE
01-109-220
22 cm
Straight, 30FR

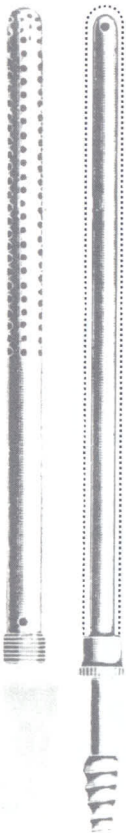

POOLE
01-110-220
22 cm
Curved, 23FR