

Tonsillen
Tonsils
Amygdales
Amigdalas
Tonsille



mm	LOVE
18	50.103.18
20	50.103.20
22	50.103.22



HOFER
50.109.24
24 cm



NAGER
50.111.23
23 cm



HURD
50.131.22
glatt · smooth · lisse
liso · liscio
22 cm
50.133.22
gezahnt · serrated
dentelé · dentado
dentellato
22 cm

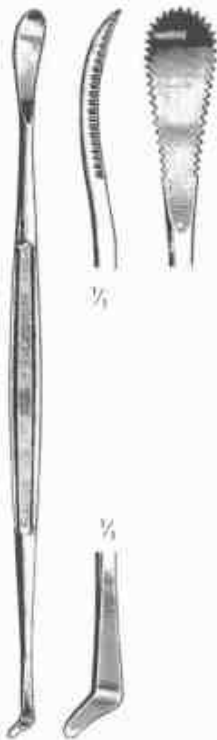

HENKE
50.135.23
23 cm



CARPENTER
50.139.25
25 cm



CARPENTER
50.143.24
24 cm



LUNIATSCHEK
50.151.19
19 cm

Tonsillen
Tonsils
Amygdales
Amígdalas
Tonsille

PROFIT[®]
Surgical Instruments

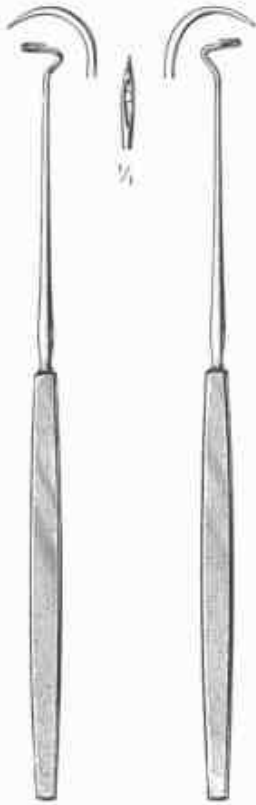

DUPUY-WEISS
50.165.22 50.167.22
22 cm

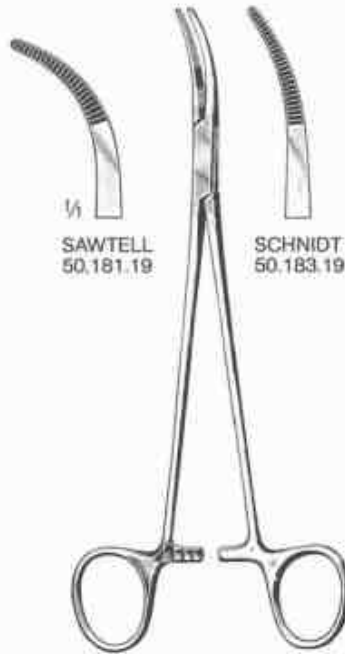

SAWTELL 50.181.19
SCHNIDT 50.183.19

50.181.19-50.183.19
19 cm

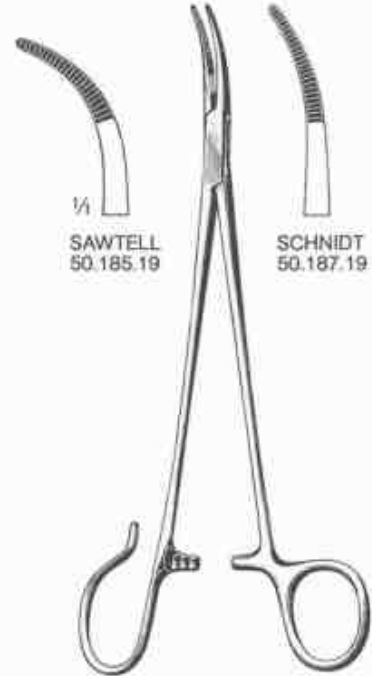

SAWTELL 50.185.19
SCHNIDT 50.187.19

50.185.19-50.187.19
19 cm

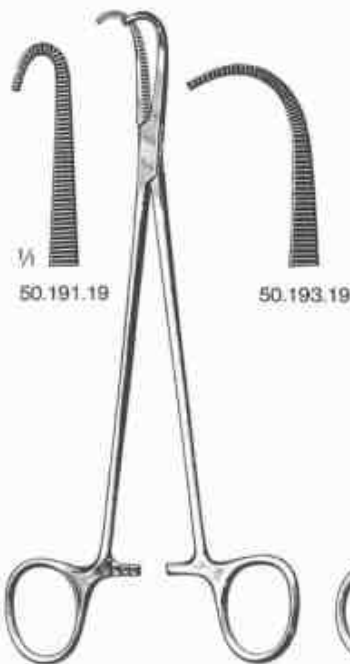

50.191.19 **50.193.19**

NEGUS
50.191.19-50.193.19
19 cm

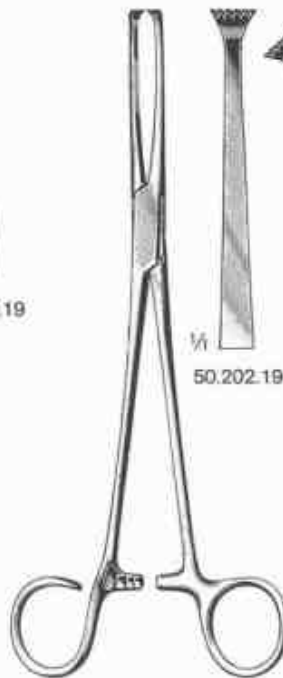

50.202.19 **50.203.19**

COLVER
50.202.19-50.203.19
19 cm



cm	WHITE
18	50.205.18
23	50.205.23

Tonsillen
Tonsils
Amygdales
Amigdalas
Tonsille



BALLENGER
50.207.21
21,5 cm



BLOHMKE
50.209.20
20 cm

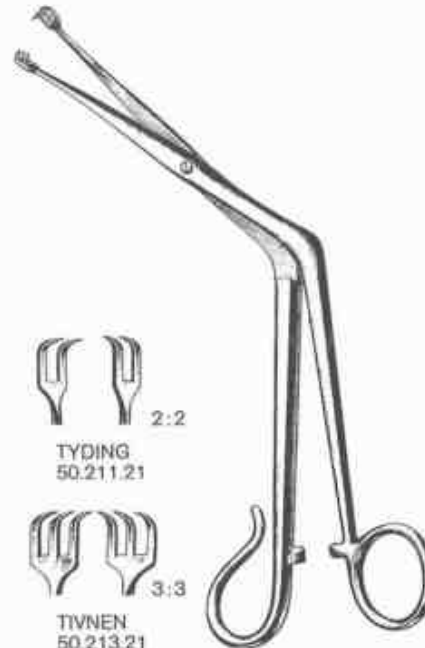

TYDING
50.211.21



TIVNEN
50.213.21

50.211.21-50.213.21
21 cm



MARSCHIK
50.219.22
22 cm



EVES
50.250.28
28 cm



EVES
50.252.28
28 cm



BRUENINGS
50.258.28
28 cm



mm	
40	50.257.40
50	50.257.50
	100 x



50.269.03
0,3 mm
12 x

Tonsillen
Tonsils
Amygdales
Amígdalas
Tonsille

PROFIT[®]
Surgical Instruments

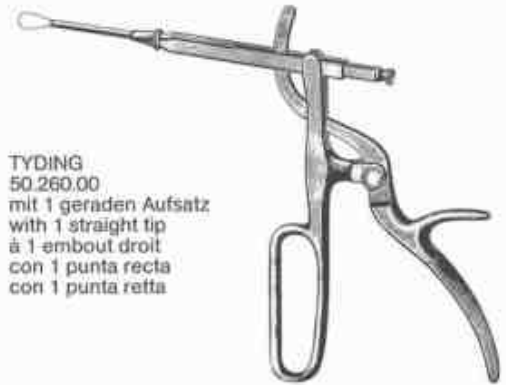

TYDING
50.260.00
mit 1 geraden Aufsatz
with 1 straight tip
à 1 embout droit
con 1 punta recta
con 1 punta reita



SLUDER-BALLENGER
50.270.00
mit 3 Aufsätzen
with 3 blades
avec 3 lames
con 3 hojas
con 3 lame



50.292.00



50.293.45
45°



50.293.90
90°

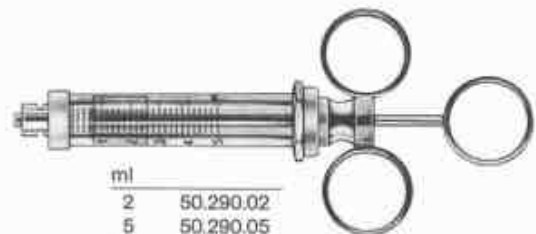

ml	
2	50.290.02
5	50.290.05
10	50.290.10